

# **Audionet**

## **MAP I**

Multi Channel Audio/Video Pre - Amplifier

### **User's Manual**



# Contents

<b>CONTENTS.....</b>	<b>3</b>
<b>PLACEMENT AND CONNECTION.....</b>	<b>4</b>
<b>ADDITIONAL EARTH CONNECTION .....</b>	<b>5</b>
<b>AUDIONET LINK .....</b>	<b>5</b>
<b>POLARISATION OF MAINS PLUG .....</b>	<b>5</b>
<b>CONNECTING THE EXTERNAL POWER SUPPLY EPS / EPX.....</b>	<b>5</b>
<b>OVERVIEW OF CONNECTIONS.....</b>	<b>6</b>
<b>AUDIO/VIDEO-CONNECTIONS .....</b>	<b>7</b>
<b>FIRST STEPS .....</b>	<b>9</b>
<b>USAGE FRONT PANEL .....</b>	<b>11</b>
<b>OVERVIEW OF MENU STRUCTURE.....</b>	<b>12</b>
<b>AUDIONET SYSTEM REMOTE CONTROL .....</b>	<b>13</b>
<b>SETUP .....</b>	<b>25</b>
<b>DISPLAY.....</b>	<b>37</b>
<b>ON SCREEN DISPLAY (OSD).....</b>	<b>41</b>
<b>PROGRESSIVE SCAN CARD .....</b>	<b>42</b>
<b>OVERVIEW VIDEO OUTPUTS.....</b>	<b>48</b>
<b>USB AUDIO .....</b>	<b>49</b>
<b>SECURITY ADVICE.....</b>	<b>53</b>

## Placement and connection



### Important:

- **Warning! Please read this manual prior to operating the MAP 1 in order to avoid damage on your valuable equipment.**

Also, please make sure all units of your audio/video system are switched off while connecting or disconnecting any cables to avoid damage of the input and/or output sections of your units.

Please make sure that your Audionet MAP 1 is installed at a place that is sufficiently ventilated to allow the heat to leave.

The mains input [17]<sup>\*)</sup> is located at the back panel of the MAP 1. Please use the provided power cord to connect the MAP 1 to mains. If you want to use a different power cord make sure that it meets the specifications for your home country.



### Important:

- **The electrical specifications at the back must meet the specifications of your home country.**
- **The mains switch at the back panel has to be switched off before connecting the MAP 1 to mains. The MAP 1 is a Class I device and must be earthed. Please ensure a stable earth connection. 'Phase'/'Hot pin' is marked at the back panel (PHASE) [17].**

The MAP 1 is a stand by device. Please use the mains switch [17] at the back panel to switch on the MAP 1. After a short time the display reads **off** or small dot to report that the unit is in stand by mode now (*see chapter 'Setup', section 'Global Setup', menu item 'Set Stand By Text'*).

Only in case of extended absence (like vacations) or if massive trouble on mains power is to be expected you should disconnect the unit from the mains. Switch off the MAP 1 with the mains switch at the back panel [17]. The display will go out.



### Important:

- **Before switching off the mains switch of the MAP 1, please make sure that all units connected to the outputs of the MAP 1 are switched off, too.**
- Long term usage of the display set to maximum brightness (setting 100%) may cause extended signs of wear resulting in a decay of contrast or brightness of individual dots in the display. Do not use the display with a brightness set higher than the factory default setting of 50% over a longer period of time (*refer to Chapter 'Audionet System Remote Control'*)!

---

<sup>\*)</sup> see numbers on page '*Overview of connections*'

## Additional earth connection

Optionally, there is a special cord available for an additional earth connection to be used with earth connector **1**. Use the screw of earth connector **1** to connect the additional ground cord to the MAP 1. Put the plug of the ground cord into a mains socket near your power cord. The sound will be improved.



### Tip:

- **We strongly recommend using the additional earth connection!**

## Audionet Link

In connection with other Audionet devices like AMP I, AMP, MAX, AMP III, AMP IV, AMP V, AMP VII etc. your MAP 1 is able to switch on/off the complete system. Please connect a Toslink plastic fibre cable from the Audionet-Link Output **8** at the back of the MAP 1 to the Audionet-Link inputs of other Audionet devices. For further instructions please read the user's manual of the other Audionet devices.

## Polarisation of mains plug

The correct polarizing of mains is important for reasons of audio clarity and stability.

Therefore the Audionet MAP 1 indicates a wrong polarisation of the mains lead. While powering up, the MAP 1 checks the mains polarisation. If you read

▶            **Attention:**            ◀  
▶ **Mains Phase incorrect** ◀

switch off the MAP and then flip the plug in your wall outlet.

## Connecting the external power supply EPS / EPX

Use the provided special cord to connect the optionally available EPS / EPX to the EPS-Input **2** at the back panel of the MAP 1. Connect **both** (!! ) units (MAP 1 **and** EPS / EPX) with mains. Switch on **first** the MAP 1 then the EPS / EPX with the mains switch at the back of the units. The MAP 1 is now in stand by mode. You can start up the MAP 1 by pressing the **power** key at the front panel, or the key **Power On** or **Power Toggle** on the remote control.

To disconnect both units from the mains please make sure first, that the MAP 1 is switched off to stand by mode using the **power** key at the front panel or the key **Power Off** or **Power Toggle** on the remote control. Now you can disconnect the units from the mains by switching off **first** the MAP 1, then the EPS / EPX using the mains switch at the back panel of the units.

# Overview of connections

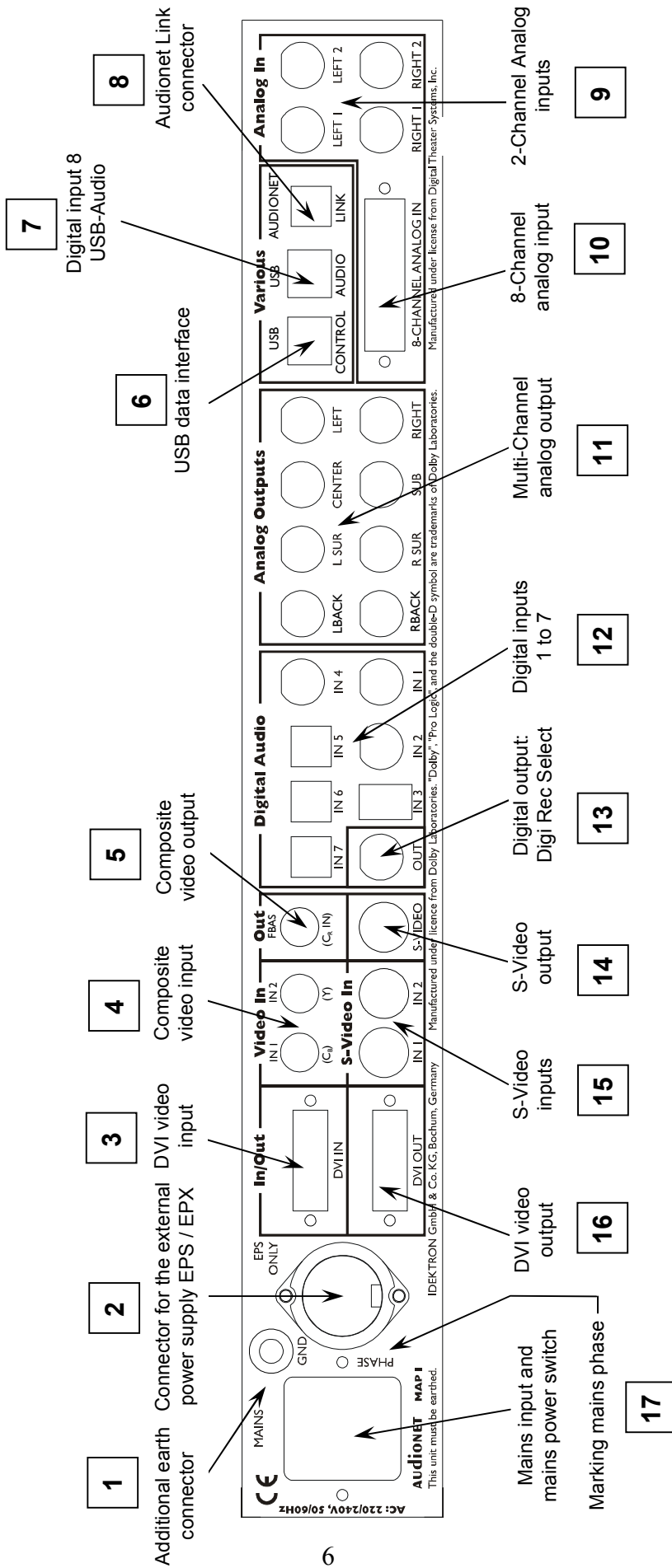

## Audio/Video-Connections

### **Analog Inputs:**

Connect 2-channel analog sources to one of the two analog inputs **9** (**Analog In LEFT 1/ RIGHT 1** or **Analog In LEFT 2/ RIGHT 2**). Both analog inputs are setup to pure analog 2-channel signal routing by default. If you have the 2-channel analog outputs of your DVD-Player, LaserDisc-Player, VCR or any other analog source connected to the MAP 1 and want to use Dolby\* Pro Logic IIx or DTS\*\* Neo:6 for decoding Surround encoded stereo material, switch internal decoder mode to **Multi-Channel** for the corresponding analog input **9** (see chapter 'Setup', section 'Decoder Setup').

If you have the optional phono card installed, plug in the MM- or MC pickup of your turn table into input **Analog In LEFT 2/ RIGHT 2 9** and connect the chassis of the turn table to the ground screw **GND 1**. The phono card offers independent selection of gain, input capacity and input resistance for optimal adjustments to all kinds of available pickup systems. For further details please refer to the enclosed user's manual of the phono card.

### **Digital Inputs (Digital Audio):**

Connect your digital sources to digital inputs 1 to 7 **12**. By factory default digital inputs 1,2,3 and 5 are setup for multi channel decoding (Dolby Digital and DTS). Digital inputs 4,6,7 and 8 are setup for stereo PCM signals (all default setting can be changed by the user in the setup menus!). Use digital input 8 **7** to connect the MAP 1 to a Computer using USB Audio to playback sound and music files (refer to chapter 'USB Audio').

In order to send DVD-Audio music data across the HighBit interface from the DVD player Audionet VIP<sup>1</sup> to the MAP 1, connect digital output 1 of the VIP with digital input **Digital Audio IN 1** of the MAP 1. Furthermore, you need a second connection running from digital output 2 of the VIP to digital input **Digital Audio IN 2** of the MAP 1. Only in case of **both** connections are setup and the switch for the interface mode on the back panel of the VIP is set to **h-bit** (refer to owner's manual of VIP), it is possible to receive and decode DVD-Audio data with the MAP 1.



#### **Note:**

- Data on the Audionet HighBit interface will be recognized and decoded automatically by the MAP 1. If the second data connection is missing the MAP 1 will issue the error message: **► Check HighBit Cable 2 ◀**. Please check the correct setup and connection of both cables from VIP to MAP 1.
- Alternatively, you can use the digital input **Digital Audio IN 3** of the MAP 1. Connect the **datalink** output of the VIP by using a common 'Firewire' or 'IEEE1396' cable with the **Digital Audio IN 3** of the MAP 1. In this case the switch

---

<sup>1</sup> Make sure your VIP supports the HighBit DVD-Audio interface. Software upgrades are available for older models.

for the interface mode on the back panel of the VIP has to be set to **h-bit mode** (refer to owner's manual of VIP), to receive and decode DVD-Audio data with the MAP 1.

**External 8-Channel Analog Inputs:**

Plug in analog multi channel sources (external decoder, DVD-Player with internal decoder, SACD-Player etc.) into the 8-channel analog input **10** of the MAP 1.



**Note:**

- The External 8-Channel Analog Input provides no signal processing at all, only pure analog volume control!

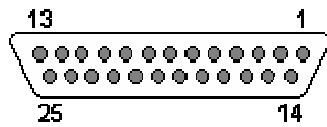

*Pin assignment External 8-Channel Analog Input*

Pin	Signal	Pin	Signal
1	Front Left	14	Ground Front Left
2	Center	15	Ground Center
3	Front Right	16	Ground Front Right
4	Subwoofer	17	Ground Subwoofer
5	Left Surround	18	Ground Left Surround
6	Right Surround	19	Ground Right Surround
7	Left Back	20	Ground Left Back
8	Right Back	21	Ground Right Back

**Analog Outputs:**

All analog outputs **11** are located in the section **Analog Outputs** in the right part of the back panel.

**Digital Outputs (Digital Audio Out):**

Select **DigiRec Select** in the setup menu, which of the digital input 1 to 7 **12** is routed to the digital output **13**. The digital record select works independently, therefore you can use digital out for recording while listening to a different source.

**Video Inputs (Video In / S-Video In):**

Plug in your cinch/composite video sources into video inputs **IN 1** and **IN 2** **4**. S-Video sources are to be connected to video inputs **S-Video In 1** and **S-Video In 2** **15**. Use the video inputs in any order as each of the 4 video inputs can be assigned to every audio input (see menu '**Video Setup**' and '**Channel Setup**'). Even multiple assignments



are allowed, i.e. one and the same video input can be assigned to more than one audio input.

### **Video Outputs:**

The video signal assigned to the current audio input is available at the **Video Out** jacks; cinch video at **FBAS** [5] and S-Video at **S-VIDEO** [14]. All video signals at the cinch video inputs are converted to S-Video format by the internal 'Cinch Video to S-Video Converter' and available at the output **S-VIDEO**. The On Screen Display (OSD) is available at video outputs **VIDEO** [5] and **S-VIDEO** [14].

Alternatively, both video inputs **VIDEO IN1** and **IN2** together with video output **FBAS** can be re-defined as secondary component video (YUV) input (*refer to chapter 'Setup' section 'Set video input' and chapter 'Progressive Scan Card' for further details and connection diagram*).

### **DVI Video In-/Outputs:**

The DVI video input and output sockets are both designed for analog and digital video signals (DVI-I). If no progressive scan card is installed, the analog or digital input signals of the DVI input socket are directly sent to the output socket (*refer to chapter 'Setup' section 'Set video input'*).



#### **Note:**

- Digital DVI video signals are **not** processed by the installed progressive scan card but only routed through from input [3] to output [16], if the option  
**Set Video Input :**  
**DVI-Int. In**  
is selected.
- Interlaced analog video formats, which are fed into a video [4], S-Video [15] or DVI analog input [3] can only be converted into a progressive digital DVI video format, if the optional progressive scan card and the optional DVI Module are both installed.
- Please refer to chapter '*Progressive Scan Card*' for detailed information about connection and configuration of the optional Progressive Scan Card.

## **First Steps**

The following provides a short overview of the first steps and their order to setup the MAP 1. For any detailed description please refer to the sections '*Usage front panel*' and '*Audionet System Remote Control*'.

After connecting your MAP 1 to the other components of your Hifi or Home Cinema system (*refer to section 'Audio / Video connections'*), some setup options have to be configured. Your MAP 1 needs information about the number of speakers, their

distances from the listening position and sensitivity to work with optimum performance. The setup procedure is quite easy if you stick to the following order:

1. **Number and size of speakers:** Use key **Bass Manager**

*(refer to chapters 'Audionet System Remote Control' and 'Setup')*

Select what kind of speakers you are using. **Large** refers to speakers that are capable of reproducing the complete bass domain down to the lowest frequencies. Use setting **Small** for bookshelf-type speakers or small sized design speakers that are not capable to produce a rich bass foundation due to their construction. According to these settings the MAP 1 determines automatically the amount of bass information that is sent to each speaker. Due to the different calculating operations that are needed for this bass management, the perceived volume level may vary between different settings.

2. **Distance of speakers to the listening position:** Use key **Delay Manager**

*(refer to chapters 'Audionet System Remote Control' and 'Setup')*

Measure the distance of each speaker to your listening position and enter the number into the Delay Manager. Your MAP 1 automatically calculates the necessary delay of each channel so that the music signals arrive at exactly the same time at your listening position. As the delay settings are calculated and setup in real time, the music signal may be influenced for the short moment of setting the new value.

3. **Level setup:** Use key **TestTone**

*(refer to chapter 'Audionet System Remote Control')*

The noise signal will support you to determine the correct level of each speaker, so all perceived volumes are the same. This setup is necessary as different speakers have different sensitivities causing different perceived volumes though the input signal has the same level.



**Note:**

- After adjusting the volume levels of all speaker channels we recommend to save these settings to all input channels as a simple start up for further channel or source dependent level settings. To save the current level settings to all input channels, press the following keys on the remote control:

**Save Setting** → **Ch-** →

Now all input channels have the same volume level settings. Of course, you can change these settings easily for each input channel independently if necessary. After these 3 steps the most important global settings are done.

Following the global setup there are lots of options that are valid for each input channel separately. These local settings are necessary to meet all the demands of different source units connected to the inputs of the MAP 1 (*please refer to section 'Setup', subsection 'Channel Setup' for further details*).

## Usage front panel

There are four keys at the front panel to control the MAP 1. Although most of the setup can be done using those keys, the included remote control provides much more comfort (refer to sections 'Audionet System Remote Control' and 'Setup').

The **power** key is used to switch on/off the MAP 1. To change volume or any settings in the setup menus, please press the **up** and **down** keys. With the **set** key you skip through the menu items of the setup menus. If you press and hold the **set** key for more than two seconds, it will get you to the next setup menu. For navigating through the menus using the remote control, please refer to chapter 'Audionet System Remote Control', section 'Navigate through a menu'.

### Example: Navigating through menus

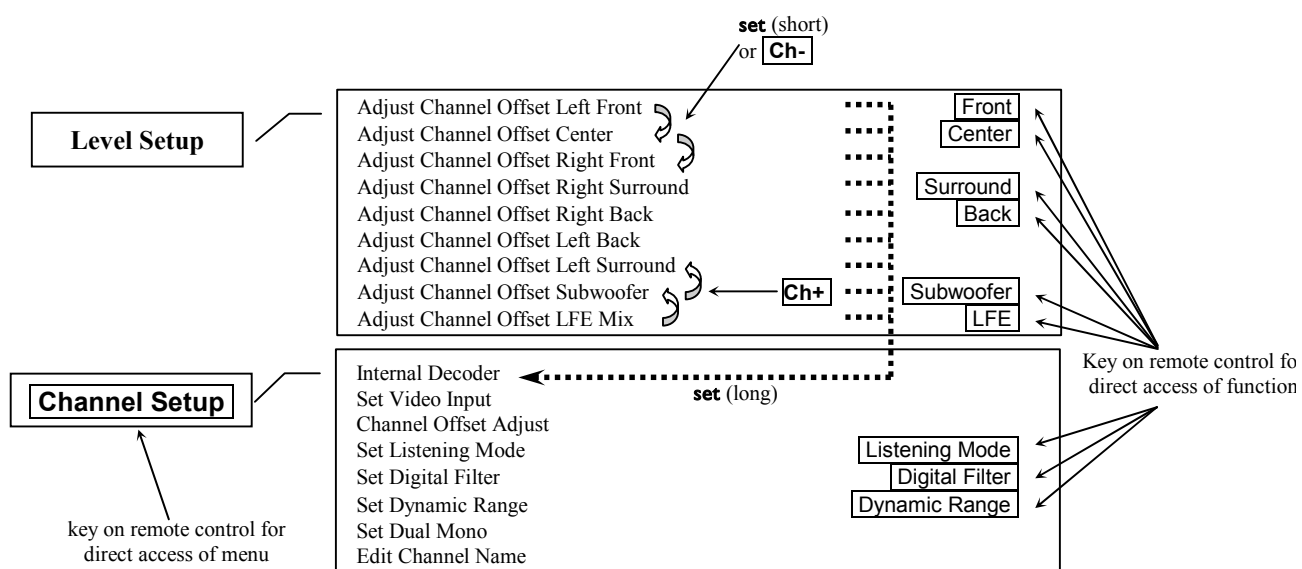

An overview of all menus and their functions is provided on the next page. Please refer to example above as legend.

Before describing all menus and their menu items, the functions of the remote control are explained in detail. Please use the remote control or, as alternative, the keys at the front panel to setup your MAP 1 according to your preferences.

# Overview of menu structure

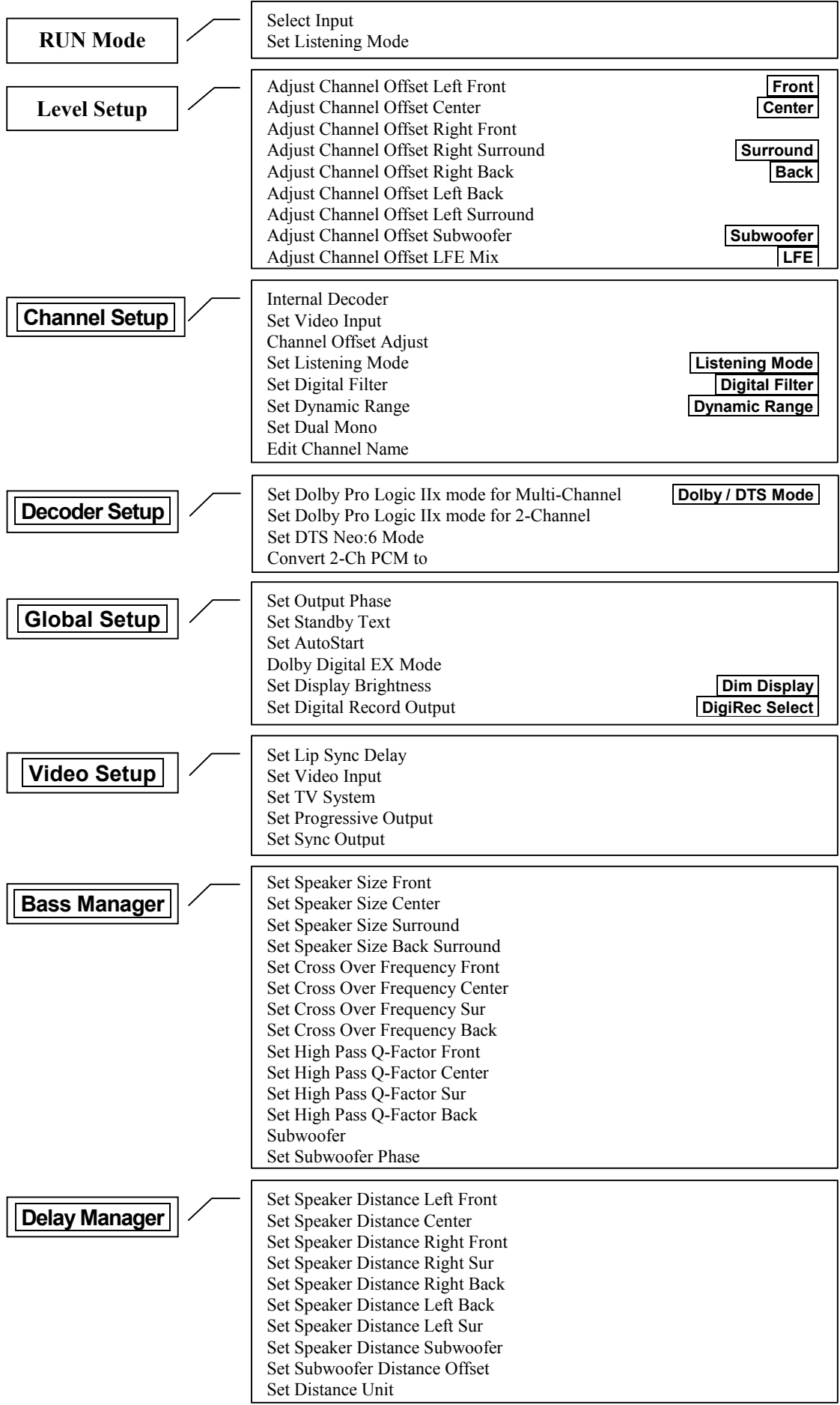



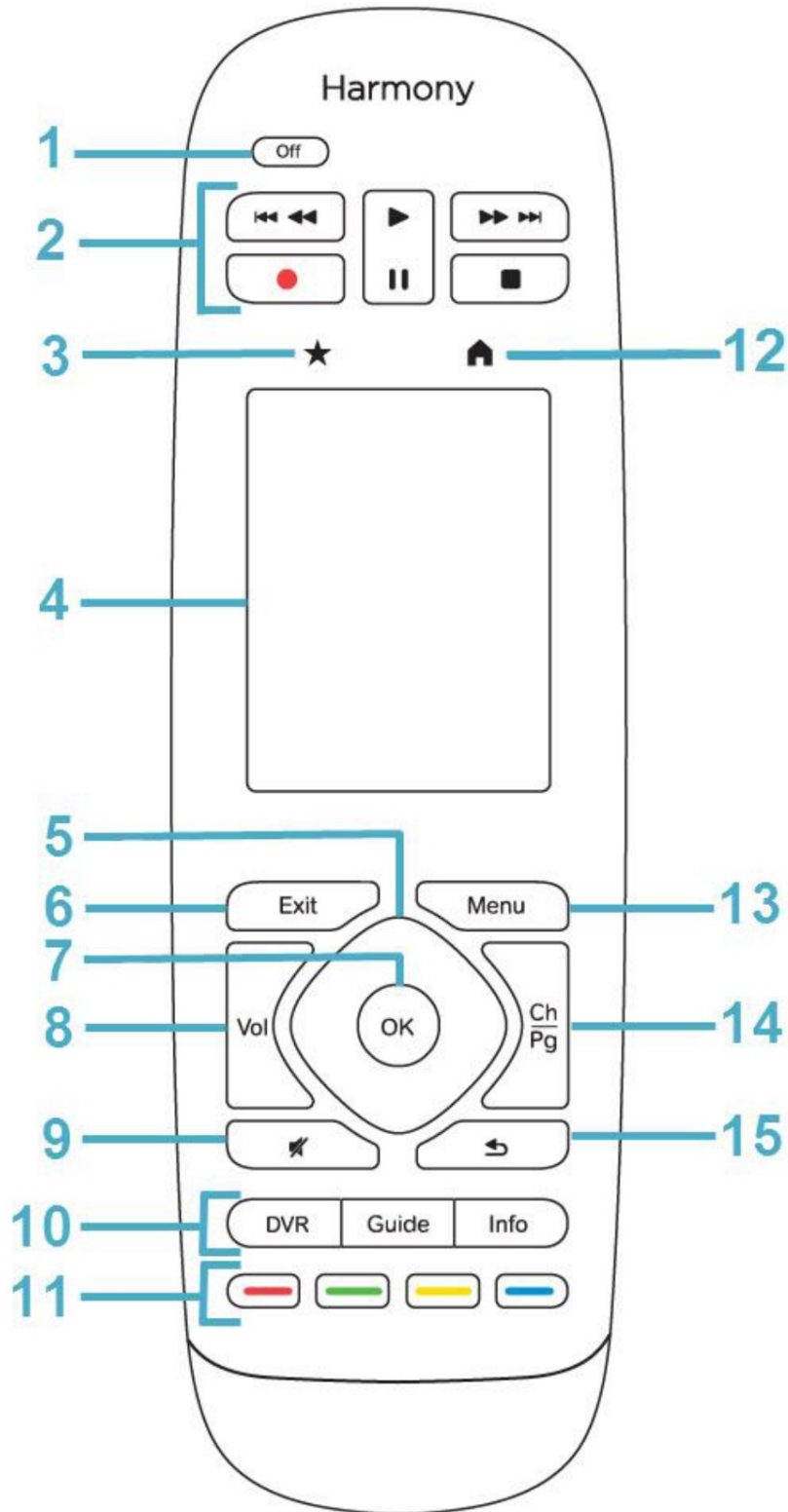

## Audionet System Remote Control

All functions of the MAP 1 can be controlled using the Audionet System Remote Control *Harmony Ultimate One*. Furthermore, it is possible to control up to 14 additional devices with the *Harmony Ultimate One*.



## Key assignment Harmony Ultimate One

No.	Key	Function
1	Off	Switch off currently active Activity; press and hold key for longer than 10 sec. to switch on/off remote control
2	Play Pause Stop	Starts, pauses or stops playback of titles via USB Audio input; Pause is not assigned
2	REC	Not assigned
2	⏮ ⏭	Skip to previous/next title (USB Audio playback only)
2	⏪ ⏩	Not assigned
3	★	Favorites: see manual Logitech; Not relevant for MAP 1
4		Touch screen, functions are labelled
5		Not assigned
6	Exit	Not assigned
7	OK	Not assigned
8	Vol + Vol -	Increases / decreases volume
9	🔇	Switch mute on / off
10	DVR Guide Info	DVR: not assigned Guide: switch on / off OSD Info: activate Show function
11		Colour keys: not assigned
12	🏠	Home: displays all programmed Activities of Harmony Ultimate One
13	Menu	Not assigned
14	Ch	Switch to next / previous input channel
15	↶	Not assigned

- 1 Power** key for use with Activities, turns all devices off that are included into the current Activity. See separate user's manual of *Harmony Ultimate One*.
-  stops playback.  starts playback. During playback, press key to pause playback at current position. Press key again to resume play at this position.  skips back to beginning of previous title.  skips ahead to beginning of next title.
- 8 Vol+** increases volume, while the MAP 1 is in RUN mode. If the MAP 1 is inside one of the setup menus, use **Vol+** to select desired setup option. This key has the same function as the key **up** on the front panel.  
**Vol-** decreases the volume, while the MAP 1 is in RUN mode. If the MAP 1 is inside one of the setup menus, use **Vol-** to select desired setup option. This key has the same function as the key **down** on the front panel.
- Press key  to mute / un-mute. Muting is carried out smoothly, i.e. the volume is stepped down or up gently.

- 10 Press key **Info** to activate the function **Show** of the MAP 1. This function provides information on the current program format as well as output and speaker configuration. For further information regarding display or On Screen Display please refer to sections "*Display*" and "*On Screen Display*". If the On Screen Display is off, it will be switched on automatically as long as the information is presented after pressing the key **Info**.

To switch on / off the On Screen Displays (OSD) use key **Guide**. This key has the same function as key **OSD** of the *Harmony Ultimate One*.



**Note:** OSD is only available on video outputs **VIDEO** and **S-VIDEO**.

- 14 **Ch+** selects the next input channel if the MAP 1 is in RUN mode. **Ch-** selects the previous input channel if the MAP 1 is in RUN mode.



**Note:**

- You can use the keys of point no. 2 above only while USB Audio playback via digital audio input 7 **USB AUDIO** **7**. Please refer to section "*USB Audio*".

You will find help for setting up your Logitech Harmony Ultimate One on the internet on Logitech's webpage:



[www.logitech.com/support/harmony-ultimate-one](http://www.logitech.com/support/harmony-ultimate-one)

<http://support.myharmony.com/en/article.htm?faqid=s-a-2166>

Download the user manual from here:

<http://cdn-www.myharmony.com/files/harmonyultimateone-usermanual-en.pdf>

### ***Using the touch screen***

Tap on the  Symbol above the touch screen of your *Harmony Ultimate One* to get a list of all your Activities. Tap now on the  symbol on the lower right and then on the key **Devices**. The screen will give you a list of all programmed devices to be controlled by your *Harmony Ultimate One*. Scroll through the list with an up or down wipe and press then the key **MAP 1** in order to control your MAP 1 with the *Harmony Ultimate One*. The **Device** mode gives you access to all remote control commands your MAP 1 understands. The following will discuss these commands in detail.

## Keys of the touch screen

Key	Function
Digital In 1	Select digital audio input <b>Digital Audio IN 1</b> [12] directly
Digital In 2	Select digital audio input <b>Digital Audio IN 2</b> [12] directly
Digital In 3	Select digital audio input <b>Digital Audio IN 3</b> [12] directly
Digital In 4	Select digital audio input <b>Digital Audio IN 4</b> [12] directly
Digital In 5	Select digital audio input <b>Digital Audio IN 5</b> [12] directly
Digital In 6	Select digital audio input <b>Digital Audio IN 6</b> [12] directly
Digital In 7	Select digital audio input <b>Digital Audio IN 7</b> [12] directly
Ext. 8ch. In	Select analog 8-channel audio input <b>8-CHANNEL ANALOG IN</b> [10] directly
USB Audio In	Select digital audio input <b>USB AUDIO</b> [7] directly
Analog In 1	Select analog audio input <b>Analog In LEFT 1 / RIGHT 1</b> [9] directly
Analog In 2	Select analog audio input <b>Analog In LEFT 2 / RIGHT 2</b> [9] directly
Dynamic Range	Adjust dynamic range
Equalizer on/off	Switch on/off digital parametric equalizer
Dolby / DTS Mode	Adjust Dolby or DTS modes
PCM Direct	Switch on/off mode "PCM Direct"
Listening Mode	Select Listening Mode
Front	Adjust volume level of Front channels
Center	Adjust volume level of Center channel
Surround	Adjust volume level of Surround channels
Back	Adjust volume level of Back Surround channels
Sub	Adjust volume level of Subwoofer channel
LFE	Adjust volume level of LFE channel
Digital Rec Select	Select output signal of digital outputs <b>Digital Audio OUT</b> [13]
Dim Display	Adjust display brightness
Digital Filter	Select digital oversampling filter for Front channels L/R



<b>OSD</b>	Switches on/off the On Screen Display
<b>Load Setting</b>	Load a User Setting
<b>Save Setting</b>	Save a User Setting
<b>Global Setup</b>	Enter menu for global setup options
<b>Channel Setup</b>	Enter menu channel specific setup options
<b>Bass Manager</b>	Enter menu of the Bass Manager
<b>Delay Manager</b>	Enter menu of the Delay Managers
<b>Video Setup</b>	Enter menu for video setup options
<b>Test Tone</b>	Switch on/off the test tone
<b>MPE +</b>	Select next filter of the current input channel (digital equalizer)
<b>MPE -</b>	Select previous filter of the current input channel (digital equalizer)
<b>Freq +</b>	Increase center frequency of current filter (digital equalizer)
<b>Freq -</b>	Decrease center frequency of current filter (digital equalizer)
<b>Gain +</b>	Increase gain of current filter (digital equalizer)
<b>Gain -</b>	Decrease gain of current filter (digital equalizer)
<b>Q +</b>	Increase Q factor of current filter (digital equalizer)
<b>Q -</b>	Decrease Q factor of current filter (digital equalizer)
<b>Power Toggle</b>	Switches on/off the MAP 1 (toggle power)
<b>Power On</b>	Switches on the MAP 1
<b>Power Off</b>	Switches off the MAP 1



### **Important**

- Please find detailed information to the keys of the touch screen in the following.



## Important

- The Power key **Off** is only available for Activities. In Device Mode the Power key has no function.
- Even without using an Activity, the user is able to control all functions of the MAP 1 using the *Harmony Ultimate One* in Device Mode.
- The keys described below to control the MAP 1 refer to the factory default programming of the Audionet System Remote Control *Harmony Ultimate One*. Understandably, any changes done to this setup by the user cannot be discussed here.



## Tip

- During everyday use, you should never need to use the **Device Mode** of your *Harmony Ultimate One*, but control the MAP 1 (and other devices of your audio setup) by customizing your **Activities**. For detailed information on how to customize and use **Activities** on your *Harmony Ultimate One* please consult the separate user's manual that came with your *Harmony Ultimate One*.
- In order to switch the MAP 1 on/off, without using an Activity, please use the keys **Power On**, **Power Off** or **Power Toggle** on the touch screen. Of course, it is possible to control the MAP 1 without any Activity, but to tap the full potential of the *Harmony Ultimate One* you need to configure Activities customized to your needs (please refer to separate manual of the remote control *Harmony Ultimate One*).



## Note

- Please read the separate user manual to your Audionet System Remote Control *Harmony Ultimate One*. Activities, Devices and Device Mode as well as customizing the remote control are discussed there. The user manual to the Audionet system remote control *Harmony Ultimate One* is available for download here:  
<http://cdn-www.myharmony.com/files/harmonyultimateone-usermanual-en.pdf>

### Navigate through a setup menu of the MAP 1:

Press a menu key to enter the corresponding menu option. Details on every menu item you will find in the following sections. To navigate through the menu items, use the **Ch+** and **Ch-** keys. Key **Ch-** has the same function as the **set** key on the front panel. To select an option, use **Vol+** and **Vol-** keys. **Vol+** works like the **up** key at the front panel, **Vol-** works like the **down** key.

There are three ways to leave a menu:

1. Press the same menu key again to get back to RUN mode.

2. Press any other menu key to enter a new menu.
3. Wait for approx. 12 seconds without using any key. After this time the MAP 1 goes back to RUN mode automatically.

- Press key **Dyn. Range** to enter **Dynamic Range** menu. Use keys **Vol+** and **Vol-** to select desired dynamic range:
 

<b>Maximum:</b>	full dynamic range, no compression at all
<b>Standard:</b>	medium dynamic range, moderate compression
<b>Minimum:</b>	minimal dynamic range, full compression



**Note:** This menu is only available, if **Internal Decoder** is set to **Multi-channel**.

- Press key **EQ** to switch on/off the double precision parametric digital equalizer.
- Use key **Dolby / DTS Mode** to enter **Decoder Setup** menu. Here you select the desired mode for Dolby Pro Logic IIX und DTS\*\* Neo:6. Additionally, you choose between Dolby Pro Logic IIX and DTS Neo:6 processing on stereo PCM signals in Listening Modes **Audionet D8**, **3 Stereo** or **Phantom**. For more detailed description refer to sections '**Setup**' and '**Menu Decoder Setup**'.



**Note:** Navigate through the menu using keys **Ch+** / **Ch-**. Change options with keys **Vol-** / **Vol+**.

- Use key **PCM Direct** to switch activate/de-activate **PCM Direct** mode. If active, the name of the currently selected input channel in the display is replaced by **---PCM Direct---**.



**Note:** You can only activate **PCM Direct** mode, if a stereo PCM signal is available at the current audio input. While in **PCM Direct** mode, the internal decoder (and therefore Bass Manager, any matrix surround processing etc.) is deactivated temporarily in order to playback stereo PCM material purely as recorded and without any changes. To leave **PCM Direct** mode press **PCM Direct** again. If a signal other than stereo PCM is detected at the current input, **PCM Direct** mode is switched off automatically. The display informs the user with the message **PCM Direct off**. **PCM Direct** mode **cannot** be activated if the MAP 1 receives digital data from an Audionet source using the HighBit interface.

- Press key **Listening Mode** to select the desired Listening Mode. See section '**Listening Mode**' for further details.
- Press key **Front** to enter the volume setup menu for **reference level (Front Left)**. Adjust the reference volume level for system level setup using the keys **Vol+** and **Vol-**.
- Press key **Center** to adjust the volume level of the Center channel using keys **Vol+** and **Vol-** (+12...-18dB).
- Press key **Surround** to adjust the volume level of the Surround channels using keys **Vol+** and **Vol-** (+12...-18dB).

- Press key **Back** to adjust the volume level of the Back Surround channels using keys **Vol+** and **Vol-** (+12...-18dB).
- Press key **Sub** to adjust the volume level of the Subwoofer channel using keys **Vol+** and **Vol-** (+12...-24dB).
- Press key **LFE** to adjust the volume level of the LFE channel using the keys **Vol+** and **Vol-** (+0...-10dB). This function affects only the LFE channel **before** it is processed by the Bass Manager.

Use the keys **Front** through **LFE** to adjust the volume levels of all output channels of your MAP 1. As soon as you press one of the keys, the MAP 1 enters the volume adjustment menu **Level Setup**. The level of the left front channel is the **reference level** of the whole system. The volume levels of all other channel are adjusted in reference to it. Therefore, if the left front channel **Front Left** is selected for adjustment the volume keys **Vol-** / **Vol+** change the master volume of the system, **not** just the level of the left front channel alone.



**Tip:**

- In order to adjust all volume levels correctly you should therefore always start with the left front channel to set the reference level for the whole system, especially if you are using an SPL meter to adjust volume levels.

If this reference level is set correctly, you are able to adjust the volume levels of all other channels easily. Use key **Ch-** to skip to the level adjustment of the next channel. Or use key **Ch+** to return to adjusting the previous channel. To change the respective volume use keys **Vol-** / **Vol+**.

By pressing keys **Surround** or **Back** the level is adjusted for **both** channels of the corresponding channel group **Surround** or **Back**. So these keys are mainly used for changing levels of the Surround or Back channels during listening. You can adjust the levels of each channel group without changing their stereo balance. In any case you can always get to the next/previous channel by using the key **Ch+** / **Ch-**.

- Press key **DigiRec Select** to decide which signal is routed to the digital outputs. Use keys **Vol-** and **Vol+** to select digital input is output at the digital output jacks **Digital Audio OUT** **13** **independently** from the current input channel. The digital signal is always available in both formats coaxial and optical. To switch off the digital outputs select **No Digital In**. Choose option **Tied to Dig. In** to route the currently selected digital input to the digital outputs respectively.
- Press key **Dim Display**, then adjust the display brightness with keys **Vol+** and **Vol-**.



**Note:** During adjustment the display stays at 100% brightness for better readability. The new selected brightness will be set after returning to RUN mode by pressing **Dim Display** again or just waiting for approx. 12 seconds without any new command input. If the display brightness is set to **Off** the display is only

activated while making any adjustment in the setup menus. It will switch off some seconds after the last change of settings.

- Press key **Digital Filter** to select the digital filter. Use keys **Vol-** and **Vol+** to choose between 4 different oversampling filters for the front channels Left/Right:
  - Audionet:** special digital oversampling filter with short pre-ringing
  - Lagrange:** short Lagrange filter
  - Blackman:** digital filter by Blackman
  - Kaiser:** digital filter by Kaiser.



**Note:** This option is only available for sample rates up to 48 kHz and not for DVD Audio using the HighBit interface.

You distinguish the four digital oversampling filters from each other by their impulse responses (*see diagrams*). Use the filter that suits your listening preferences. Do not hesitate to experiment with the different filter settings.

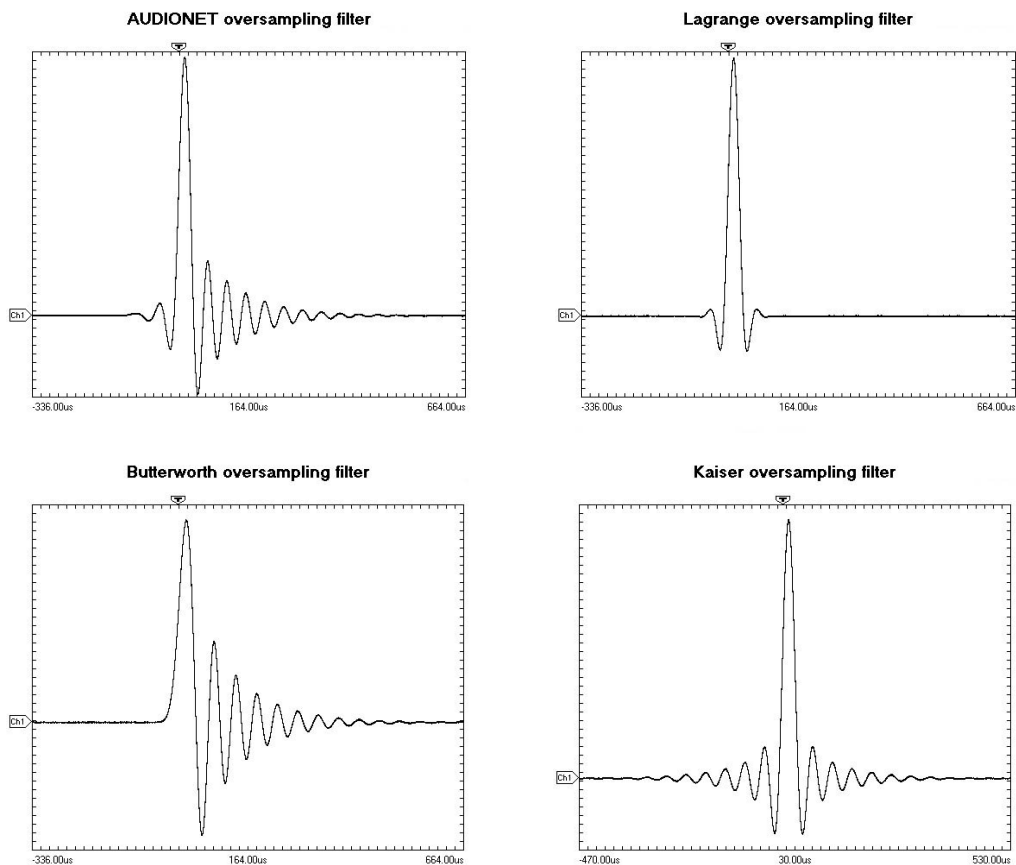

- Use key **OSD** to switch on/off the On Screen Display (OSD) of your MAP 1. This key has the same function as key **Guide** of the *Harmony Ultimate One*.
  - Note:** The OSD is only available at video outputs **Video Out** in Cinch Video format (**FBAS** **5**) and S-Video format (**S-VIDEO I** **14**).
- Press key **Load Setting** to re-load previously saved user settings. Select the user setting you like to load by using the keys **Vol-** and **Vol+**. Press **⏏** to load

selected user setting. All current settings will be overwritten during load.

You can choose a name up to 14 characters in length for each of the 30 user settings. To change a name press key **Ch+**. A cursor marks the character to be changed by pressing **Vol-** or **Vol+** (see also **Edit Channel Name**). Move cursor one position to the right by pressing **↔**. While the cursor is active, you get to the names of the other user settings with keys **Ch+** and **Ch-**. To leave edit mode press **Load Setting** again.

- To save the current settings as user setting press key **Save Setting**, and choose one of the 30 memory spaces with the **Vol-** and **Vol+** keys. All data at the corresponding memory location is overwritten by the current settings after pressing the **↔** key.

You can simply assign the current user setting to only one input channel or even to all input channels at once. Press **Ch+** and select the input channel with **Vol-** or **Vol+**. Then press **↔** to transfer the current settings to the selected input channel. Press **Ch+** again to enter mode to assign current settings to **all** input channels. Press **↔** to start data transfer.

A user setting comprises: Volume and balance levels of all output channels, **PCM Direct** mode status, dynamic range, Dolby Pro Logic IIx and DTS Neo:6 mode, Listening Mode and Digital Filter. 30 memory locations for storing user settings are available. The user can assign a name up to 14 characters in length to each user setting. Additionally, each of the 12 input channels saves automatically all current settings independently (channel settings). The 30 memory locations (user settings) can only be accessed by the user when using the **Save Setting** function. So they are independent from the channel settings.



**Note:** Current master volume, speaker settings, state of internal decoder, video options etc. are saved automatically and independently when changing a setting and/or switching off the MAP 1.



**Note:** After adjusting the volume levels of all output channels we recommend to save these found settings to all input channels as a simple start up for further channel or source dependent level settings. To save the current level settings to all input channels press the following keys:

**Save Setting** → **Ch-** → **↔**

Now all input channels have the same volume level settings. Of course, you can change these settings easily for each input channel independently, if necessary.

- **Channel Setup** enters the **Channel Setup** menu.
- **Bass Manager** enters the **Bass Manager** menu.
- **Global Setup** enters the **Global Setup** menu.
- **Delay Manager** enters the **Delay Manager** menu.
- **Video Setup** enters the **Video Setup** menu.

- Press key **TestTone** to start the internal test tone generator. The generator delivers a noise signal to the Front Left channel. You can now adjust the reference level with keys **Vol-** / **Vol+** as described above. Press key **Ch-** to produce the noise signal in the next channel. Or use key **Ch+** to skip back to the previous channel. **Ch-** moves the noise signal clockwise (according to your speaker positions in your listening room) from one channel to the other, **Ch+** selects the channels anti clockwise. Adjust the level of each selected channel so that all channels reproduce the noise signal of the test tone generator with the same volume. Press **TestTone** again to switch off the test tone generator and return to RUN mode.



**Note:** No test tone is available on the Subwoofer output!

The next 8 keys on the touch screen are used to configure the parametric, digital equalizer. If the MAP 1 is in any other mode than the setup mode for the equalizer, pressing one of the 8 keys invokes the setup mode for the equalizer. Then the keys have the following functions:

Key **Ch-** selects the next channel, key **Ch+** the previous channel. While in the equalizer setup mode you are still able to adjust the master volume using keys **Vol-** / **Vol+**.

Leave the equalizer setup mode by using one of the other setup menu keys. The MAP 1 then enters the corresponding menu. If you wait for approx. 12 seconds without pressing any key, the MAP 1 will return to RUN mode automatically.

- **MPE+** selects the next MPE filter of the current channel.
- **Freq-** decreases the center frequency of the current MPE filter.
- **Freq+** increases the center frequency of the current MPE filter.
- **Q-** decreases the Q-factor of the current MPE filter.
- **Q+** increases the Q-factor of the current MPE filter.
- **Gain-** decreases the gain factor of the current MPE filter.
- **Gain+** increases the gain factor of the current MPE filter.

\*) MPE = Minimum Phase Equalizer



**Tip:**

- For further information on the use and configuration of an parametric, digital equalizer please refer to the documentation of the analyser software CARMA which is available for download free of charge on our internet site [www.audionet.de](http://www.audionet.de).
- If the MAP 1 is in stand-by mode, press key **Power On** to switch the unit on.

- Use **Power Toggle** to switch on/off the MAP 1. This key has the same function as the key **power** on the front panel. If the MAP 1 is in stand-by mode, **Power Toggle** will switch on the unit. If the MAP 1 is already switched on, **Power Toggle** will switch off the unit to stand-by mode.
- If the MAP 1 is switched on, use key **Power Off** to switch the unit off to stand-by mode.



# Setup

## *Description of all menu items*

### **RUN mode:**

This is the normal operation mode, if no menu is selected. Use **Vol-** and **Vol+** keys to adjust the master volume. The display shows name and number of the selected input channel in the 2<sup>nd</sup> line. The 3<sup>rd</sup> line shows the current volume (*see chapter 'Display'*).

### **Select Input:**

Use **up** and **down** keys to select desired input channel. The input channels are aligned in the following order: **Digital In 1 to 7** [12], **USB** [7], **External 8ch In** [10] and **Analog In 1 and 2** [9].

### **Listening Mode:**

Use **Vol-** and **Vol+** keys to select the Listening Mode for Dolby Digital, Dolby Pro Logic IIx, DTS decoding or DVD Audio (via Audionet HighBit Interface).

**Mono:** all program material is downmixed to mono

**Stereo:** reproduces 2-channel source material as 2-ch Stereo, turns off Dolby Pro Logic IIx or DTS Neo:6 decoding, any other multichannel material is downmixed to Stereo output (2/0 Lo/Ro). Mono signals are re-routed from the Center channel to both Front Left and Right channels.

**Phantom:** information on the Center channel is re-routed to Front Left and Right channels

**3Stereo:** reproduces audio programs using only the three front channels (L,C,R)

**Surround:** reproduces all channels originally available in the program material, 2-channel Stereo is reproduced as Stereo (*see table 'Overview Listening Modes'*).

**Audionet D8:** reproduces all available channels of the program material. Additionally, material with stereo encoded surround channels is always extended to 7.1 channels. 2-channel Stereo is expanded by Dolby Pro Logic IIx or DTS Neo:6 to 6.1 or 7.1 channels (*see table 'Overview Listening Modes'*).

**Party Mode:** all input material is downmixed to 2-channel Stereo and distributed to all available speakers as follows:

Front Left	=	Surround Left	=	Back Left
Front Right	=	Surround Right	=	Back Right
Center	=	½ Front Left + ½ Front Right		



**Note:** With this Listening Mode mono signals can be reproduced in every speaker.

**Lt/Rt out:** all program material is downmixed to Stereo output (2-ch Lt/Rt) for later Dolby Pro Logic IIx or DTS Neo:6 decoding (recommended for recording Dolby Digital / DTS programs on 2-channel recording devices like VCRs)

**Note:**

This menu is only available, if **Internal Decoder** is set to **Multi-Channel** or DVD Audio playback.

**Overview Listening Modes:**

Program	Audionet D8	Surround
<b>2-Channel formats</b>		
PCM	Dolby Pro Logic IIx <sup>2)</sup> or DTS Neo:6 <sup>4) 1)</sup>	Stereo PCM
Dolby Digital 2/0 (not Surround encoded)	Dolby Digital + Pro Logic IIx <sup>2)</sup>	Dolby Digital 2/0
Dolby Digital 2/0 (Surround encoded)	Dolby Digital + Pro Logic IIx <sup>2)</sup>	Dolby Digital + Pro Logic IIx <sup>2)</sup>
DTS 2/0 (not Surround encoded)	DTS Neo:6 <sup>3)</sup>	DTS 2/0
DTS 2/0 (Surround encoded)	DTS Neo:6 <sup>3)</sup>	DTS Neo:6 <sup>3)</sup>
<b>Multi channel formats</b>		
Dolby Digital	Dolby Digital + Pro Logic IIx <sup>2)</sup>	Dolby Digital <sup>5)</sup>
DTS	DTS + Neo:6 <sup>4)</sup>	DTS <sup>5)</sup>
Dolby Digital (Dolby Surround EX encoded)	Dolby Digital + Pro Logic IIx <sup>2)</sup>	Dolby Digital EX <sup>6)</sup>
DTS-ES Matrix	DTS-ES Matrix <sup>4)</sup>	DTS-ES Matrix <sup>4)</sup>
DTS-ES Discrete	DTS-ES Discrete <sup>4)</sup>	DTS-ES Discrete <sup>4)</sup>
DTS 96/24	DTS 96/24 + D8 <sup>7)</sup>	DTS 96/24 <sup>5)</sup>

\*1) The decoder mode is defined by the function **Convert 2-ch PCM to** in menu **Decoder Setup** (see chapter '**Setup**', section '**Decoder Setup**'). Additional options are available by function **Set Dolby Pro Logic IIx Mode for 2-Channel** or **Set DTS Neo:6 Mode** (see chapter '**Setup**', section '**Decoder Setup**').

\*2) The decoder delivers a 7-channel output. The Back Surround speakers playback a stereo signal.

\*3) The decoder delivers a 6-channel output. The Back Surround speakers playback a mono signal each.

\*4) same as 3). Additional options by function **Set DTS Neo:6 Mode** (see chapter '**Setup**', section '**Decoder Setup**').

\*5) The decoder delivers a 5-channel output. The Back Surround speakers playback no signals.

\*6) same as 3). Additional options by function **Dolby Digital EX Mode** (see chapter '**Setup**', section '**Decoder Setup**').

\*7) The decoder delivers a 5-channels output. Additionally, the Back Surround speakers playback the signals of the Surround speakers.

## Menu Channel Setup

This menu comprises all settings, that are valid only for the current selected input channel. If you change the input channel, all settings are saved automatically and the channel settings for the new channel are loaded. Therefore, you can adjust the MAP 1 to each connected source independently, and don't have to worry about saving and re-loading the settings you made. The MAP 1 will do the work automatically.

### Internal Decoder:

In order to switch off the internal decoder, press key **Vol-** (the display shows **pure 2-channel**). All program material is downmixed to 2-ch Stereo independently from the original program format. Dolby Pro Logic IIx or DTS Neo:6 decoding, bass and delay management are off in this mode. It is strongly recommended to use this mode for Stereo PCM or 2-channel analog sources only.

Press key **Vol+** to activate the internal decoder (the display shows **Multi-Channel**). All incoming program formats (PCM or bitstream) are detected and decoded automatically (see also section '*PCM direct*').



#### Note:

- The internal decoder can be activated for all audio inputs except the external 8-channel analog input (**External 8ch**).
- If the internal decoder is active for a 2-channel analog audio input, the input signals are internally converted from analog to digital. Now all functions like Dolby Pro Logic IIx or DTS Neo:6 decoding, bass and delay management, digital equalizer etc are available as for any digital audio input.
- The internal analog to digital converter has an input sensitivity of  $2 V_{RMS}$ . If input signals exceed this level, the converter will overload causing audible distortions. In this case, reduce the output level of the unit connected to the MAP 1 until no overload occurs.

### Set Video Input:

You can assign one of the video inputs (2 cinch video inputs **4**, 2 S-Video inputs **15**, 1 DVI input **3**, 1 alternative YUV/RGB input) to each input channel independently. Even multiple assignments are allowed (e.g. for connecting a DVD player that uses more than one audio output). If no video input is needed for an audio input, please select **No Video Input**.

**No Video Input**

No video input is selected.

**Video In1 or In2**

The corresponding video input **IN1** or **IN2** **4** is selected.

**S-Video In1 or In2**

The corresponding S-Video input **S-VIDEO IN1** or **S-VIDEO IN2** **15** is selected.

**DVI-Int. In**

The video input **3** is used for **analog and digital** DVI signals (DVI-I) which are routed directly to the DVI output **16**.

## Cinch Analog

The video inputs **4** and video output **5** are re-defined in their function to be used for component video input. Their **analog** signals are routed directly to the analog part of DVI output **16**.



### Note:

- If you assign any of the Cinch (or Composite) video inputs **4** to an audio input, you will have a video signal at the Cinch/Composite video output **5** as well as at the S-Video output **14** (automatically converted by the internal 'Cinch-to-S-Video Converter').
- If the optional Progressive Scan Card is inserted, some more video inputs and options are available. In this case, please refer to chapter '*Progressive Scan Card*' for more detailed information.
- This menu item is located in the menu **Channel Setup**, as it is a setting, that can be selected for each input channel independently. Although the menu **Video Setup** deals with global video settings, the same function **Set Video Input**, as described above, is also integrated into the **Video Setup** menu, simply for an easier access.
- For each audio input the corresponding video input is assigned individually. To simplify this procedure, select the desired video input for each audio input during the setup (of channel levels, names, decoder settings etc) for this audio input.

## Offset Adjust:

Use **Vol-** and **Vol+** keys to adjust the input channel offset. You can add gain or attenuate each input channel individually within a range of +9...-9dB in order to compensate different output levels of sources connected to the MAP 1.

## Set Listening Mode:

This menu item has the same function as the key **Listening Mode** on the remote control described above.

## Digital Filter:

This menu item has the same function as the key **Digital Filter** on the remote control described above.

## Dynamic Range:

This menu item has the same function as the key **Dynamic Range** of the remote control described above.

## Set Dual Mono:

Select the preferred playback mode for DVD soundtracks in Dual Mono mode with the **Vol-** and **Vol+** keys.

- |                    |  |
|--------------------|--|
| <b>CH1+CH2 :</b>   | Both Dual Mono channels are reproduced |
| <b>CH1 only ::</b> | Only Dual Mono channel 1 is reproduced |
| <b>CH2 only :</b>  | Only Dual Mono channel 2 is reproduced |



**Note:**

- This menu is only available, if **Internal Decoder** is set to **Multi-Channel**.

**Edit Channel Name:**

While in menu **Channel Setup** proceed to this menu item by pressing key **Ch-** if menu item **Set Dual Mono Mode** is highlighted, or by pressing **Ch+** while menu item **Set Decoder** is highlighted.

For each input channel you can choose a name up to 14 characters in length. A cursor (↑) marks the current character to be changed by pressing **Vol-** and **Vol+** keys. Press key **↔** to move the cursor to the right onto the next character position. At the end of the character string the cursor jumps back to the first position after pressing the key **↔**.

### **Menu Decoder Setup**

Use this menu to select the desired operating modes and options for Dolby Pro Logic IIx and DTS Neo:6 decoding.



**Note:**

- This menu is only available, if the internal Decoder is active (option **Internal Decoder** is set to **Multi-channel**).

### **Set Dolby Pro Logic IIx Mode:**

Dolby Pro Logic IIx expands original 2- or 5.1-channel material to 6.1- or 7.1-channel output using a matrix technology. Depending on the original format the following options are available:

#### **Menu item for Multi-Channel:**

Select the preferred mode for expanding 5.1-channel program material to 6.1- or 7.1-channels using Dolby Pro Logic IIx by using the **Vol-** and **Vol+** keys:

**Movie:** The **Movie** mode is optimal for 5.1-channel movie soundtracks or stereo soundtracks that are Dolby Surround encoded.

**Music:** Not all 5.1 material may sound ideal when decoded with Dolby Pro Logic IIx in the **Movie** mode. Use mode **Music** if the soundfield is focused too much on the Back Surround speakers.

**Dolby D EX:** Dolby Digital EX creates six full-bandwidth output channels from 5.1-channel sources. This is done using a matrix decoder that derives three surround channels from the two in the original recording.

#### **Menu item for 2-Channel:**

Dolby Pro Logic IIx offers 4 different modes for decoding 2-channel sources. Select your preferred mode with the **Vol-** and **Vol+** keys:

**Movie:** The **Movie** mode is for use with stereo TV shows and all Dolby Surround encoded programs. The result is an enhanced soundfield directionality that approaches the quality of discrete 5.1-channel sound.

**Music:** The **Music** mode is for use with any stereo music recordings, and provides a wide and deep sound space. The **Music** mode includes controls (CenterWidth, DimensionControl and Panorama), that allow the sound to be tailored to your listening tastes. All three of these controls may be used alone or in any combination. After you experimented with them on a few programs, you will easily understand their effect and consider which setting you may prefer.

**Pro Logic:** Original Dolby Pro Logic mode.

**Matrix:** The **Matrix** mode is the same as the **Music** mode except, that the directional enhancement logic is turned off. It may be used to enhance mono signals by making them seem 'larger'. The **Matrix** mode may also find use, if fluctuations from poor stereo reception (of FM radio, TV or satellite receivers) cause disturbing surround signals from a logic decoder.

Because music recording techniques and listening preferences vary so widely, no single decoding setting is likely to be adequate for all content. Therefore, Dolby Pro Logic IIx incorporates a separate **Music** mode to reproduce a convincing and compelling surround ambience from conventional stereo sources. The **Music** mode generally includes three controls for fine-tuning the soundfield to get the most pleasing or natural effect.



**Note:**

- These options are only available, if the **Internal Decoder** is set to **Multi-Channel** and the Dolby Pro Logic IIx mode **Music** is selected. Use key **Ch-** while menu item **Dolby Pro Logic IIx Mode for 2-Channel** is selected:

**Center Width (OSD: Cntr Width):**

This control allows center channel sounds to be positioned between the Center speaker and the Left/Right speakers over a range of 8 steps. Step 3 uses a combination of all three front speakers to give the best vocal imaging and most seamless soundstage presentation, and is recommended for most recordings. Step 0 places all center sound in the Center speaker. Step 7 places all center sound equally in the Left/Right speakers, just as in conventional stereo. The Center Width control is automatically preset to 3 in the **Movie** mode.



**Note:**

- This menu item is only available, if the **Internal Decoder** is set to **Multi-Channel** and the Dolby Pro Logic IIx Mode **Music** is selected.

**Dimension Control (OSD: Dimension):**

This control allows the user to gradually adjust the soundfield either towards the front or towards the rear. This can be useful to help achieve the desired balance from all the speakers with certain recordings, that may contain either too much or too little spatial

effect. Step 0 is the recommended setting, which has no effect on the sound. Steps 1, 2 and 3 gradually move the sound forward, and steps -1, -2, -3 move the sound towards the surrounds. The Dimension control is automatically preset to 0 in the **Movie** mode.



**Note:**

- This menu item is only available, if the **Internal Decoder** is set to **Multi - Channel** and the Dolby Pro Logic IIX Mode **Music** is selected.

**Panorama:**

This control extends the front stereo image to include the surround speakers for an exciting 'wraparound' effect with side wall imaging. It is particularly effective for recordings which have strong left or right channel elements in the mix, as these are detected and accentuated by the Panorama process. The Panorama control is automatically turned off in **Movie** mode.



**Note:**

- This menu item is only available, if the **Internal Decoder** is set to **Multi-Channel** and the Dolby Pro Logic IIX Mode **Music** is selected.

**Set Neo:6 Mode (OSD: DTS Neo:6 Mode):**

DTS Neo:6 generates a 6-channel soundfield from an original 2-channel source using a matrix technology. Two user selectable modes are available:

**Cinema:** The Cinema mode is suitable for matrix encoded stereo source material (like movie or TV soundtracks).

**Music:** Use the Neo:6 mode **Music** for stereo music material, that did not use any surround matrix encoding technologies during recording. Neo:6 produces a soundfield with up to 6 channels, that does not diminish the subtleties and integrity of the original stereo recording.

**Set Neo:6 Option Cgain (OSD: ▶ CntrGain):**

If the DTS Neo:6 mode **Music** is selected, the user can influence and, by using the option **Cgain**, adjust the soundfield to his listening preferences. **Cgain** changes the amount of Center signals mixed to the Left and Right channels. The Center channel level is not influenced by setting **Cgain**.

The user can adjust **Cgain** from 0.0 to 0.5 in steps of 0.1. If **Cgain = 0.0**, the Left and Right channels are played back unchanged referring to the original stereo mix. The higher the value of **Cgain**, the more dominant is the sound of the Center channel.

**Menu item Convert 2-Ch PCM to:**

Use keys **Vol-** and **Vol+** to select the desired matrix decoder technology to expand stereo PCM signals to 6 or 7 channels:

**Dolby PLIIX:** Select this option to use Dolby Pro Logic IIX. The options selected by function **Dolby PL IIX Mode for 2-Ch** are used (see above).

**DTS Neo:6:** Select this option to use DTS Neo:6. The settings from function **DTS Neo:6 Mode** are applied (see above).

## **Menu Global Setup**

This menu adjusts *global* options for the MAP 1, which are saved automatically when switching off the unit to stand by mode and re-loaded automatically when switching on. Select the **Global Setup** menu by pressing key **Global Setup**.



### **Note:**

- The first selected menu item of the On Screen Display is always **Output Phase** although it is not the top item. The reason is, that the first two items in the menu both are accessible directly via keys on the remote control. Of course, you can select both items using the keys **Ch+** / **Ch-** to navigate through the menu.

### **Output Phase:**

Press **Vol+** key to invert the phase of all output channels (**inverted**). Use this option for CDs, that were recorded with inverted phase. Press **Vol-** key to set phase back to **normal**.

### **Set Standby-Text:**

With this option you can specify how the stand by mode is shown in the display. There are following possibilities to choose:

- Dot:** Please press the **Vol-** key. The stand by mode is indicated by a little point in the display.
- Off:** Please press the **Vol+** key. The stand by mode is indicated by the text **off** in the display.



### **Note:**

- In both cases the display position of the stand by text changes every 12 seconds in a random pattern to prevent a 'burn in' of the display.

### **Set AutoStart:**

To enable the AutoStart option press **Vol+** key (**On**), to disable press **Vol-** key (**Off**). If the AutoStart option is active, the MAP 1 will start up automatically when connected to mains. Use this option, if you want to start up the MAP 1 by timer.



### **Dolby Digital EX Mode:**

Use keys **Vol-** and **Vol+** to select, if for Listening Mode **Surround**, Dolby Surround EX encoded bitstreams are recognized and played back in Dolby Digital EX mode automatically, or if they are played back like plain Dolby Digital bitstreams:

**auto on:** The 'Dolby Surround EX encoded' flag in the bitstream is recognized and the playback mode is set to Dolby Digital EX automatically.

**never on:** The 'Dolby Surround EX encoded' flag in the bitstream is ignored. The bitstream is decoded in Dolby Digital mode.



#### **Note:**

- This setting refers to Listening Mode **Surround only!** For Listening Mode **Audionet D8** all Dolby Digital bitstreams are decoded as **Dolby Digital + Pro Logic IIx** independent from the flag 'Dolby surround EX encoded'. The user settings of function **Dolby Pro Logic IIx Mode for Multi-Channel** apply (see chapter '*Setup*', section *Menu 'Decoder Setup'*).
- See also table '**Overview Listening Modes**'.

### **Menu Video Setup**

This menu adjusts global video options for the MAP 1, which are saved automatically when switching off the unit to stand by mode and re-loaded automatically when switching on. Select the **Video Setup** menu by pressing key **Video Setup**.

#### **Set Lip Sync Delay:**

While using video processors in projectors, progressive scan modules etc. the video signal may be delayed in reference to the audio signal, so that picture and sound are not in sync any longer. Use keys **Vol-** / **Vol+** to adjust a delay of the audio output of the MAP 1 to get picture and sound in sync again. The delay can be adjusted from 0 to 100 msec in steps of 0.5 msec.



#### **Note:**

- Adjusting the **Lip Sync delay** does not affect the delay settings of each output channel relative to each other. It is only for synchronising picture and sound.

#### **Set Video Input:**

This is the same function as in the **Channel Setup** menu. It is also integrated here for easier access.



#### **Note:**

- The video input setting applies to each audio input channel independently! All other video settings within the Video Setup menu are valid globally.

### Set TV System:

For correct conversion from Cinch video to S-Video please select the corresponding TV System. Press **Vol-** key for NTSC. Press **Vol+** for PAL.

All other items in the **Video Setup** menu relate to an optional Progressive Scan Card. Please refer to chapter '*Progressive Scan Card*'.

### Menu Bass Manager

Use items in the **Bass Manager** menu to match the MAP 1 to the speakers in your system. Navigate through the menu using keys **Ch+** / **Ch-**, select options with keys **Vol-** / **Vol+**.

#### Set Speaker Size:

Speaker settings are adjusted by channel groups:

Front	=	Front Left and Right
Center	=	Center
Surround	=	Surround Left and Right
Back	=	Back Left and Right

First, choose the method how the bass of the selected channel group is reproduced:

- None:** speaker(s) of this channel group is/are not available.
- Small:** Bass below the cross over frequency (**Cross Over Frequency**) is redirected to subwoofer channel or to any speaker selected as **Large**, if no Subwoofer is available. Please use this option for small speakers, that are not capable of reproducing frequencies below the cross over frequency.
- Large:** the speaker(s) of this channel group reproduce the full frequency range. Select this option, if your speakers are able to reproduce bass below the crossover frequency.
- X-Bass:** same as **Large**, but additionally the bass below the cross over frequency of this channel group is re-routed to the Subwoofer. Use this setting if you want to drive your speaker in full range, but also create a stronger bass foundation.
- Note:** As now the speaker(s) of this channel group and the subwoofer reproduce the bass of this group, an unwanted bass gain could occur. In this case switch to setting **Large** or **Small**
- Note:** This option is only available, if a subwoofer is connected and the option **subwoofer** set to **available**.

#### Set Cross Over Frequency:

Now you have to adjust the cross over frequency (**Cross Over Frequency**) for the speakers of the current channel groups. It defines the point of operation of the corresponding filter of the Bass Manager (see '*Set Speaker Size*'). Use keys **Vol-** and

**Vol+** to select the cross over frequency. Navigate through the menu by using keys **Ch+** / **Ch-**.

### Set High Pass Q:

Adjust the Q factor of the current high pass filter. The default setting is 0.71 and should only be altered by experts.

### Subwoofer:

If a subwoofer is available in your speaker configuration, press **Vol+** key to activate it (**available**). If a subwoofer is not available, press **Vol-** key to deactivate the subwoofer channel (**not available**).



#### Note:

- You can only switch off the subwoofer, if Front speakers are set to **Large** and no channel group is set to **X-Bass**. Otherwise the display shows **Configuration not allowed** if you press **Vol-** key.

### Set Subwoofer Phase:

Select phase of the Subwoofer to **normal** or **inverted**.



#### Important:

The following additional conditions apply to the Bass Manager:

- Channel group **Front** can not be set to **None**.
- If **Front** is set to **Small** all other channel groups are forced to **Small** and the Subwoofer is activated.
- Only if channel group **Surround** is available (= not **None**), group **Back** can be selected to any other than **None**.
- If channel group **Surround** is switched to **None**, group **Back** is forced to **None** automatically.
- If the Subwoofer is **not available** and one of the channel groups is set to **X-Bass**, the Subwoofer will be activated automatically (set to **available**).
- If any channel group is set to **X-Bass**, the Subwoofer cannot be deactivated.

## **Menu Delay Manager**

Use this menu to enter the distances from your speakers to your listening position (**Set Speaker Distance**). The distance ranges from 0 to 1500 cm in steps of 5cm. Alternatively, you can enter the distances in inches (*see 'Set Distance Unit'*). According to the entered distances, the MAP 1 calculates the necessary delays of each channel to ensure, that all signals from all speakers arrive at the same time at the listening position.

Use keys **Vol-** and **Vol+** to enter the distance, select channel to be setup with keys **Ch+** / **Ch-**. The order of channels is the same as in the **Level Setup** menu.

### **Subwoofer Distance Offset:**

This option 'virtually' moves the subwoofer relative to the listening position (= adjusting the 'phase' of the subwoofer). Use **positive** values, if you want to **delay** the signal from the subwoofer relative to all other channels. Use **negative** values, if the signal from the subwoofer should arrive **earlier** than the signals from all other speakers.

### **Set Distance Unit:**

To choose the unit for measuring the distances of speakers, use **Vol+** to select **Centimeter** or **Vol-** to select **Inches**. Distances already entered into the system are converted to the selected unit automatically.

## Display

While in RUN mode the 2<sup>nd</sup> line of the display provides the (user definable) channel name (14 characters long) followed by the number of the input channel (**D1** to **D7** for Digital In 1 to 7, **An1** and **An2** for Analog In 1 and 2, **Ex8** for 8ch External Input, **USB** for USB Audio playback).

If the internal decoder is inactive (**Internal Decoder** set to **pure 2-channel**), the volume is displayed in the third line as **Stereo Volume -xxdB** with **xx** = current volume of the current input channel. If the internal decoder is active, the 3<sup>rd</sup> line changes to **Master Volume -xxdB** with **xx** = current master volume of all channels. So the user can easily see, if the internal decoder is active or disabled.

### Example:

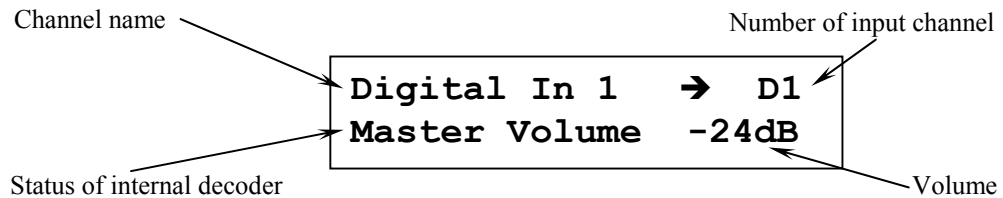

If using a digital input, the 1<sup>st</sup> line of the display will show **Receiver Out Of Lock!** while there is no valid digital signal at the current input. If a valid signal is detected by the digital receiver, the 1<sup>st</sup> line changes to **Receiver locked** for a moment. If the internal sampling rate converter is active, the display shows **SRC active**. After that information about program format, output and speaker configuration follows. Press **Info** key at any time to force the display to show this information. After some seconds, the display returns to showing volume information.

Every program format, the current decoding and output format is displayed as the following:

### Example:

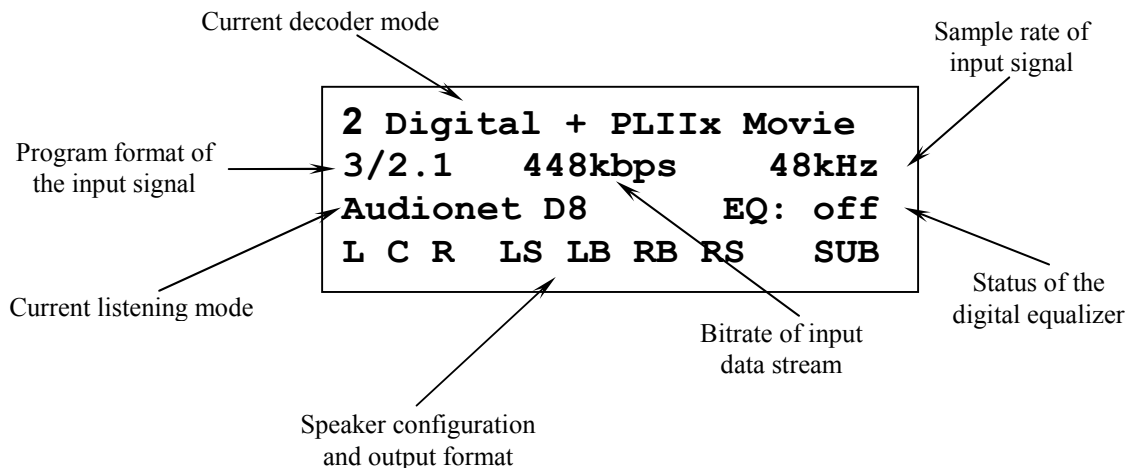

The 1<sup>st</sup> line shows information about the current decoder mode:

Display	Decoder mode
Test Tone on	Test tone generator is active
2-Channel Analog Input	pure 2-channel analog playback
<b>Stereo PCM input signals</b>	
PCM 2-Ch Stereo	2-channel PCM is played back as stereo
PCM A/D converted 2-Ch	analog-to-digital converted stereo signal
2 Pro Logic IIx Movie	Dolby Pro Logic IIx in Movie mode
2 Pro Logic IIx Music	Dolby Pro Logic IIx in Music mode
2 Pro Logic IIx Matrix	Dolby Pro Logic IIx in Matrix mode
2 Pro Logic	Dolby Pro Logic IIx in Pro Logic mode
DTS Neo:6 Cinema	DTS Neo:6 in Cinema mode
DTS Neo:6 Music	DTS Neo:6 in Music mode
<b>Bitstream input signals</b>	
2 Digital	Dolby Digital
2 Digital EX	Dolby Digital EX
2 Digital+PLIIx Movie	Dolby Digital with Pro Logic IIx in Movie mode
2 Digital+PLIIx Music	Dolby Digital with Pro Logic IIx in Music mode
2 Digital+PLIIx Mtx	Dolby Digital with Pro Logic IIx in Matrix mode
2 Digital+Pro Logic	Dolby Digital with Pro Logic IIx in Pro Logic mode
2 Digital 2-ch Stereo	Dolby Digital played back as 2-channel stereo signal
DTS Digital Surround	DTS Digital Surround
DTS ES Discrete	DTS-ES Discrete
DTS ES Matrix	DTS-ES Matrix
DTS + Neo:6 Cinema	DTS with Neo:6 in Cinema mode
DTS + Neo:6 Music	DTS with Neo:6 in Music mode
DTS 96/24	DTS 96/24
DTS 96/24 + Audionet D8	DTS 96/24 with Audionet D8
DTS 2-Channel Stereo	DTS played back as 2-channel stereo signal
<b>Input signals via Audionet HighBit interface</b>	
Audionet HighBit	MAP 1 receives audio data from Audionet source (e.g. VIP G3 or ART G2) via Audionet HighBit interface

On the left of the 2<sup>nd</sup> line the **program format** of the input signal is displayed by:

<b>m/n . x</b>	<b>m</b> = number of front channels
	<b>n</b> = number of surround channels
	<b>x</b> = 1 → LFE <sup>1)</sup> is available
	= 0 → LFE <sup>1)</sup> is not available.

While receiving digital input signals, the current **sample rate** is shown on the left of the 2<sup>nd</sup> line.

If the input signal is a bitstream (like Dolby Digital or DTS), the current **bitrate** is displayed as kbps (kbit per second) in the middle of the 2<sup>nd</sup> line. In case of a PCM input signal information about the usage of **emphasis** during recording is shown instead of the bitrate:

<b>EMPH</b>	recorded using emphasis
-	no emphasis used.

The 3<sup>rd</sup> line informs about the current **Listening Mode** and the **status of the digital equalizer**.

The 4<sup>th</sup> line provides information about the **output and speaker configuration**. If a speaker is available in the current speaker configuration, and it is supported by the current Listening Mode, the corresponding letter is printed in the display:

<b>L</b>	=	Left Front
<b>C</b>	=	Center
<b>R</b>	=	Right Front
<b>LS</b>	=	Left Surround
<b>RS</b>	=	Right Surround
<b>BL</b>	=	Back Left
<b>BR</b>	=	Back Right
<b>BC</b>	=	Back Center <sup>2)</sup>

If a speaker is used by the program material, the corresponding letter is printed inversely in the display.

If the subwoofer is active, it is displayed by an inverse **SUB**. Otherwise this symbol is not printed.

---

<sup>1)</sup> LFE is the Low Frequency Effects channel in the program material.

<sup>2)</sup> if only one speaker is available in the channel group Back



**Note:**

- Is the brightness set to **OFF** the display is only on during setup or volume adjustments. It switches off automatically several seconds after the last user entry.
- The MAP1 activates the 'display saver' automatically after 10 minutes without any user entry.
- During active 'display saver', the display shows only the number of the selected input channel and current volume level (example: **An1 -47dB**). The display brightness is always reduced to 25%, and the location of the information text will change randomly every 12 seconds to prevent any 'burn-in' effect of the display. If the MAP1 is muted the text **mute** is displayed instead of the volume level. Error messages are abridged.
- The 'display saver' is de-activated and the display returns to its normal mode as soon as any user entry is detected
- The user cannot switch off the automatic 'display saver' function!
- Use the key **Info** of the remote control at any time to display full information on the current status



## On Screen Display (OSD)

Activate the On Screen Display by pressing the key **OSD** or **Guide** on the remote control. The signal of the OSD is available at the video outputs in Cinch video **5** and S-Video format **14** and replaces the current video image. Press **OSD** or **Guide** again to switch the On Screen Display off. Now the current video image is back at the video output.

In RUN mode OSD shows information about input format, speaker configuration and their usage by current program material, emphasis for PCM CDs, state of the digital equalizer, currently active Listening Mode, sample rate, master volume and current video and audio input.

If any of the setup menus is selected, the OSD shows the corresponding dialog. The currently selected option is marked by a black bar in the background and yellow text.

### Example:

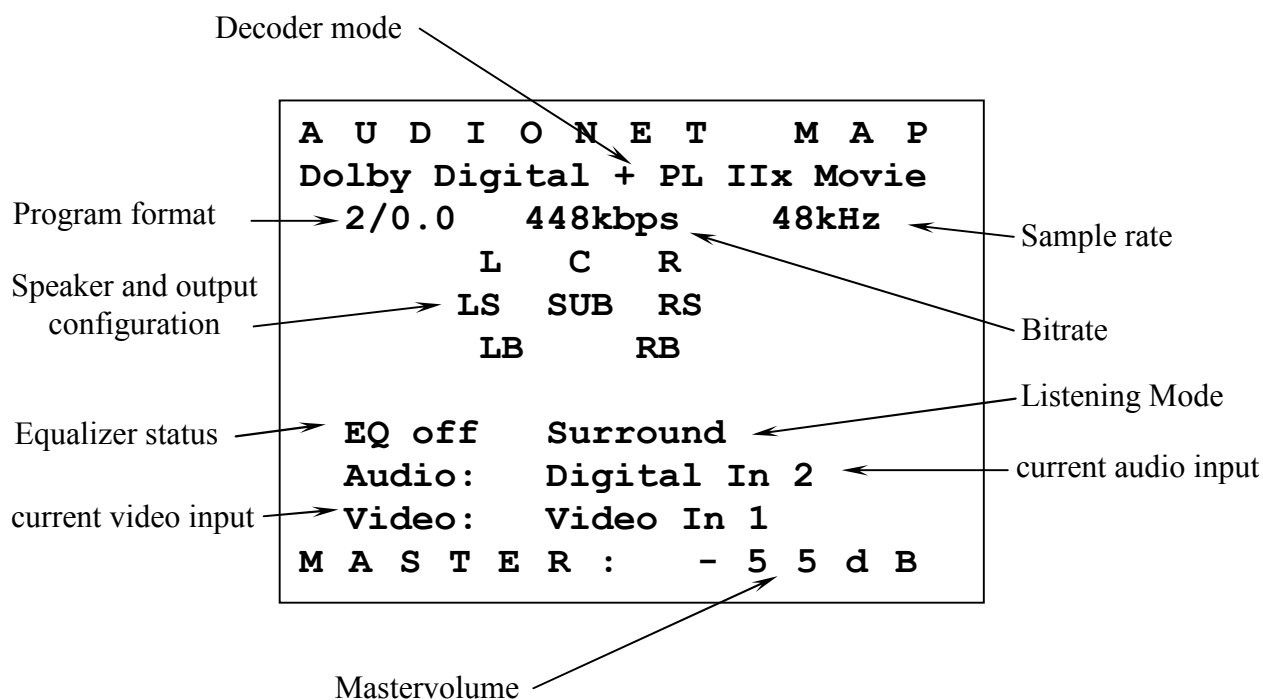

## Progressive Scan Card

The optional Progressive Scan Card is recognized by the MAP 1 automatically and needs no special system setup. The configuration of the Progressive Scan Card refers only to simple adjustments to meet the needs of the video display (video beamer/projector, plasma TV etc) connected to the MAP 1. The Progressive Scan Card offers several video inputs that are selectable as easy as the Cinch (Composite) and S-Video inputs using the **Set Video Input** function in the **Channel Setup** or **Video Setup** menu. Please find a detailed description in the following.

### Using video inputs with installed Progressive Scan Card:

You can connect and use the Video- [4] and S-Video inputs [15] of the MAP 1 with a Progressive Scan Card installed in the same way as without the card. The video signal of the currently active video input is fed to and processed by the Progressive Scan Card internally.

If the Progressive Scan Card is installed, additional video inputs are available. You select these inputs as usual using function **Set Video Input**. You get to this function by entering either the **Channel Setup** or the **Video Setup** menu. If you are in the device menu MAP 1 of the remote control, press the following keys to get to the function **Set Video Input**:

Or: 

Video Setup	→	Ch-
Channel Setup	→	Ch-

Now use keys **Vol-** and **Vol+** to select the desired video input for the currently active audio input.



#### Note:

- To each audio input the user can assign a video input separately. The easiest way to achieve this, is to assign the video input while you setup the individual settings (like level adjustments, name assignment, decoder settings etc) for each audio input (*see chapter 'Setup', section 'Menu Channel Setup'*).

Please consult the user's manual of your video source (DVD player, LD player, VCR etc), which video format is available at its video outputs and choose a compatible video input of the MAP 1. The following video inputs are selectable for each audio input individually, if the Progressive Scan Card is installed:

<b>No Video Input</b>	No video input selected.
<b>Video In1 or In2</b>	The corresponding (composite) video input <b>IN1</b> or <b>IN2</b> [4] is selected.
<b>S-Video In 1 or In2</b>	The corresponding S-Video input <b>S-VIDEO IN1</b> or <b>S-VIDEO IN2</b> [15] is selected.
<b>DVI-Int. In</b>	Video input [3] is used for <b>digital and analog</b> DVI video signals (DVI-Integrated). The signal will <b>not</b> be processed by the Progressive Scan Card, but directly routed from the DVI input connector [3] to the DVI output connector [16]. Please use this

setting for **digital and analog** DVI video signals already in the progressive format.

**Cinch Analog**

The video inputs [4] and video output [5] are re-defined in their function to be used for component video input. Their **analog** signals are routed **directly** to the analog part of DVI output [16]. Use this setting for **interlaced or progressive** signals, that should **not** be processed by the Progressive Scan Card.

**DVI YUV In**

Video input [3] is configured for YUV video signals in interlaced format (see connection diagram below).

**DVI RGB In**

Video input [3] is configured for RGB video signals in interlaced format. The Sync signals are connected separately as H/V Sync or C-Sync (see connection diagram below).

**DVI RGB+sog**

Video input [3] is configured for RGB video signals in interlaced format. The Sync signals are provided on the Green signal line: **sog** = Sync On Green (see connection diagram below).

**Cinch YUV In**

Video inputs **INI** and **IN2** [4] and video output **FBAS** [5] are re-defined as component (YUV) analog video input for interlaced component (YUV) signals (see connection diagram below).

**Cinch RGB+sog**

Video inputs **INI** and **IN2** [4] and video output **FBAS** [5] are re-defined as RGB analog video input for interlaced RGB signals with sync signals on Green signal line: **sog** = Sync On Green (see connection diagram below).



**Note:**

- The Progressive Scan Card will process **interlaced** video signals **only!** Use settings **DVI-Int. In** or **Cinch Analog** for signal already in progressive format.

**Connector pin assignment DVI input [3]:**

As follows you can find the assignment of DVI input connector [3] for the different analog video formats. Use these overview to choose the right cable for connecting your video device.

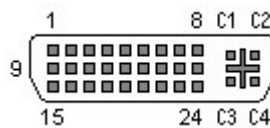

Pin assignment of the DVI input connector

DVI input connector		Analog video input format			
Pin	Signal	YUV	RGB + H/V-Sync	RGB + C-Sync	RGB + Sync on Green
8	Analog Vertical Sync	-	V-Sync	-	-
C1	Analog Red	U	R	R	R
C2	Analog Green	Y	G	G	G + Sync
C3	Analog Blue	V	B	B	B
C4	Analog Horizontal Sync	-	H-Sync	C-Sync	-



**Note:**

- Many devices use the SCART connector for RGB video output. If your video source is equipped with a SCART output connector (e.g. the Audionet DVD player VIP), it has to be connected as follows:

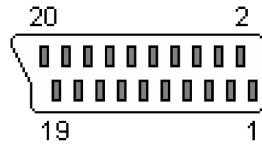

Pin assignment of the SCART-connector

Signal	SCART Pin	DVI Pin
Red	15	C1
Green	11	C2
Blue	7	C3
C-Sync	19	C4

Connection diagram for YUV or RGB video input using video inputs **4** and output **5**:

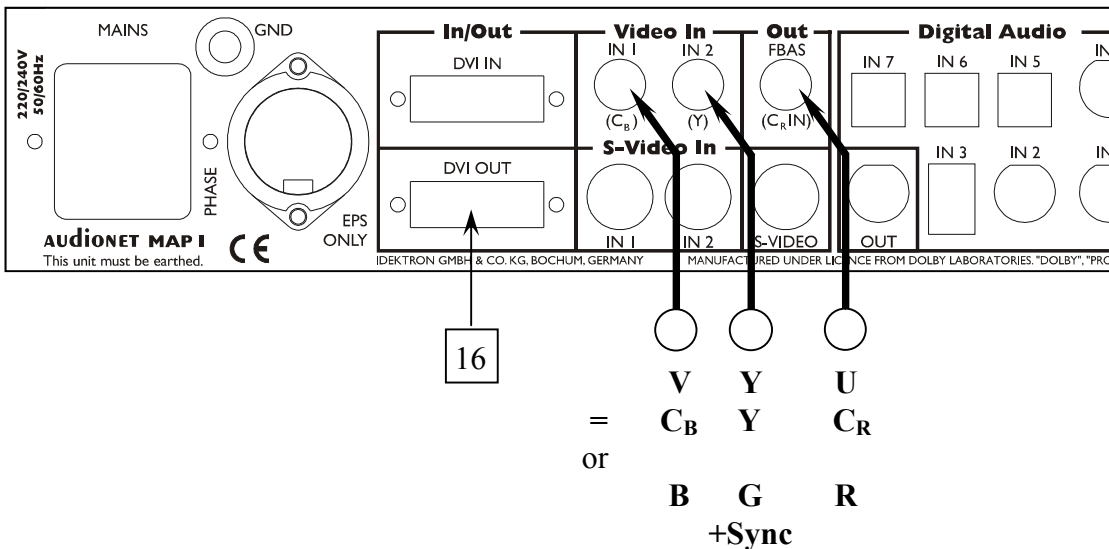

from output of video source

**Video outputs Progressive Scan Card:**

The output signal of the Progressive Scan Card is available at video output **16**. If only the Progressive Scan Card (and not the DVI Module) is installed, pins 8 and C1 to C4 of the DVI video connector provide the analog progressive video signal (see chapter 'Pin assignment DVI output connector')



**Note:**

- If the optional DVI Module is installed too, the progressive video signal of the Progressive Scan Card is provided in digital DVI format at the video output connector **16**.
- If the optional DVI Module is installed, the progressive video signals are always available in digital and analog format at the DVI output connector **16**.

The user can choose between the two output video formats YUV and RGB by menu setup. The selection adverts always to the analog as well as the digital progressive video output format. If you are in the device menu MAP 1 of the remote control, press keys:

**Video Setup** → **Ch+** → **Ch+**

to get to function **Set Progressive Output**. Now use keys **Vol-** and **Vol+** to select desired video output format:

**Y U V** The MAP 1 provides a progressive Component or YUV signal at the DVI Video output **16** (*refer to connection diagram below*).

**R G B** The MAP 1 provides a progressive RGB signal at the DVI Video output **16**.

**Note:** Before you can use the RGB video output, you have to select the correct output mode for the Sync signals (*please refer to connection diagram and detailed description below*)!



**Important:**

- For the **analog** RGB video output mode only, it is necessary to select the correct Sync output mode using function **Set Video Out**. If you are in the device menu MAP 1 of the remote control, press the following keys to enter the function:

**Video Setup** → **Ch+**

Now use keys **Vol-** and **Vol+** to select desired option:

**C-Sync** Pin C4 of the DVI output connector **16** provides the C-Sync (Composite Sync) signal, which is used for RGB video output with a combined sync signal (C-Sync).

**H/V-Sync** Pin 8 of the DVI output connector **16** provides the V-Sync (Vertical Sync) signal and pin C4 the H-Sync (Horizontal Sync) signal for RGB video output with separate sync signals.



**Note:**

- Please consult the user's manual of your video display (projector, video beamer, plasma TV etc) connected to the MAP 1 to decide which video output format is to be used!

**Pin assignment DVI output connector 16 (analog signals):**

As follows you can find the assignment of DVI output connector 16 for the different analog video formats. Use this overview to choose the right cable for connecting your display device.

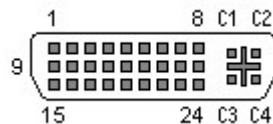

*Pin assignment of the DVI output connector*

DVI output connector		Analog video output format			
Pin	Signal	YUV	RGB + H/V-Sync	RGB + C-Sync	RGB + Sync on Green
8	Analog Vertical Sync	-	V-Sync	-	-
C1	Analog Red	U	R	R	R
C2	Analog Green	Y	G	G	G + Sync
C3	Analog Blue	V	B	B	B
C4	Analog Horizontal Sync	-	H-Sync	C-Sync	-

**Settings for analog YUV video output:**

If your video display has a video input for progressive Component or YUV video signals, connect the MAP 1 according to the diagram above and make the following settings (like described above):

**Set Progressive Output**     =     **Y U V**  
**Set Sync Out**                     =     **C-Sync**

**Settings for analog RGB-video output with C-Sync:**

If your video display has a video input for analog progressive RGB video signals with a C-Sync (= Composite Sync) input, connect the MAP 1 according to the diagram above and make the following settings (like described above):

**Set Progressive Output**     =     **R G B**  
**Set Sync Out**                     =     **C-Sync**

**Settings for analog RGB-video output with H/V-Sync:**

If your video display has a video input for analog progressive RGB video signals with separate H-Sync/V-Sync inputs, connect the MAP 1 according to the diagram above and make the following settings (like described above):

**Set Progressive Output**     =     **R G B**  
**Set Sync Out**                     =     **H/V-Sync**

### Settings for analog RGB-video output with 'Sync on Green':

If your video display supports only RGB video signals with Sync signals on the Green line ('Sync on Green'), connect the MAP 1 according to the diagram above and make the following settings (like described above):

**Set Progressive Output** = **R G B**  
**Set Sync Out** = **C-Sync**



#### Note:

- This video format uses only three lines to connect the MAP 1 to the video display as the Sync signals are transmitted on the same line as the Green signal ('Sync on Green').



#### Important:

- For this video output mode it is necessary to set the jumper on the Progressive Scan PCB to position 'SyncOnGreen' (see diagram below). For all other modes, the jumper has to be in position 'Syncless Component' (default setting).

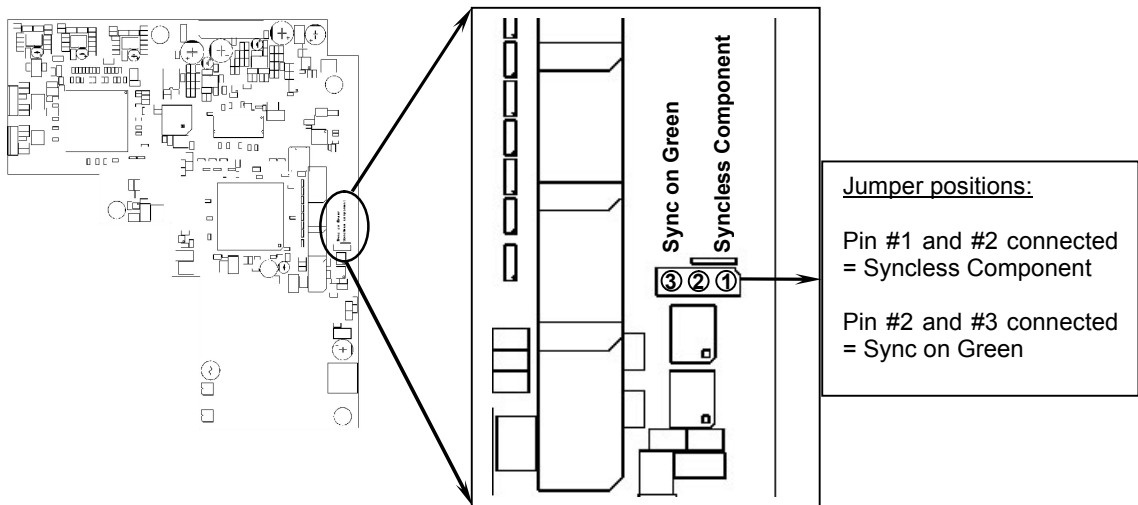

## Overview video outputs

### Without Progressive Scan Card:

Video Input	Video Output			
	FBAS Out	S-Video Out	DVI Analog Out	DVI Digital Out
Video In1/2	FBAS	S-Video	-	-
	OSD	OSD	-	-
S-Video In1/2	-	S-Video	-	-
	OSD	OSD	-	-
Cinch Analog In	-	-	equal to input <sup>1)</sup>	-
	- <sup>2)</sup>	OSD	-	-
DVI Analog In	-	-	equal to input <sup>3)</sup>	-
	OSD	OSD	-	-
DVI Digital In	-	-	-	equal to input <sup>3)</sup>
	OSD	OSD	-	-

- 1) The video signal is routed directly from the alternative component video input [4], [5] to the analog part of the DVI output [16] without any processing (**Set Video Input = Cinch Analog**).
- 2) In this mode the video output **FBAS** [5] is re-defined as video input.
- 3) The video signal is routed directly from the DVI input [3] to the DVI output [16] without any processing (**Set Video Input = DVI-Int. In**).

### With Progressive Scan Card:

Video Input	Video Output			
	FBAS Out	S-Video Out	DVI Analog Out <sup>4)</sup>	DVI Digital Out <sup>4)</sup>
Video In1/2	FBAS	S-Video	progressive analog	progressive digital <sup>1)</sup>
	OSD <i>interlaced</i>	OSD <i>interlaced</i>	OSD <i>progressive</i>	OSD <i>progressive</i> <sup>1)</sup>
S-Video In1/2	-	S-Video	progressive analog	progressive digital <sup>1)</sup>
	OSD <i>interlaced</i>	OSD <i>interlaced</i>	OSD <i>progressive</i>	OSD <i>progressive</i> <sup>1)</sup>
Cinch Analog In	-	-	progressive analog or equal to input <sup>5)</sup>	progressive digital <sup>1)</sup>
	- <sup>2)</sup>	OSD <i>interlaced</i>	OSD <i>progressive</i>	OSD <i>progressive</i> <sup>1)</sup>
DVI Analog In	-	-	progressive analog or equal to input <sup>3)</sup>	progressive digital <sup>1)</sup> or equal to input <sup>3)</sup>
	OSD <i>interlaced</i>	OSD <i>interlaced</i>	OSD <i>progressive</i>	OSD <i>progressive</i> <sup>1)</sup>
DVI Digital In	-	-	-	equal to input <sup>3)</sup>
	OSD <i>interlaced</i>	OSD <i>interlaced</i>	OSD <i>progressive</i>	OSD <i>progressive</i> <sup>1)</sup>

- 1) with installed DVI Module only; otherwise no output!
- 2) In this mode the video output **FBAS** [5] is re-defined as video input.
- 3) Both analog and digital video signals are routed directly from the DVI input [3] to the DVI output [16] without any processing (**Set Video Input = DVI-Int. In**).
- 4) The function **Set Progressive Output** determines, if the output signal uses YUV or RGB colour space.
- 5) The video inputs [4] and video output [5] are re-defined in their function to be used for component video input. Their **analog** signals in interlaced or progressive format are routed directly to the analog part of DVI output [16] (**Set Video Input = Cinch Analog**).



## USB Audio

With the USB Audio interface you can playback music and sound files from your computer using the MAP 1 instead of the soundcard of the PC. The MAP 1 is integrated into your computer system as USB Audio device. The installation is done (mostly) automatically via Plug'n'Play, provided a correctly installed operating system.





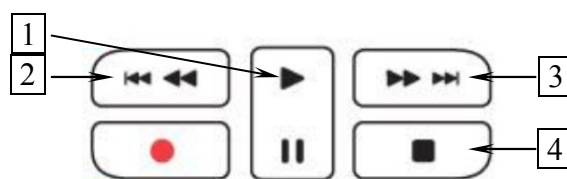

### Note:

- To use the USB Audio functions of the MAP 1, your computer requires to have Microsoft™ Windows™ 98SE, Windows ME™, Windows 2000 Professional or Windows XP™ Home/Professional with the latest USB Audio drivers installed. For further information about the minimum system requirements please refer to the documentation of your Microsoft Windows version in use.

In case you have Microsoft Windows 2000 Professional or Windows XP Home/Professional installed on your computer you can use the remote control *Harmony Ultimate One* of the MAP 1 to control your application software playing back your sound and music files (usually the Windows Media Player).



- 1 , starts playback. During playback, press key to pause playback. Press again to resume playback at current position.
- 2 , skips back to start of previous track.
- 3 , skips forward to start of next track.
- 4 , stops playback. Press key  to resume playback from start of current track.



### Note:

- In order to control your application with the remote control of the MAP 1, the program has to be running and its window active. For further information on how to start and work with your application please refer to its user's manual.

### Connecting the MAP 1 to your computer:

Connect digital input 8 **USB Audio**  with a suitable USB cable (plug type A to plug type B) to a free USB port at your computer that is compatible to USB 1.1 or above and supports the Full Speed USB protocol.

### Installation and configuration of your computer:

As soon as you connect the MAP 1 to your computer and switch on the unit, the newly added hardware is recognized by your computer. Depending on the Microsoft Windows version installed on your system, it might occur that the operating system prompts you to install a driver for the new hardware. In this case let Windows choose the correct driver automatically and follow the installation dialog until its finished. If necessary, Windows may prompt you to insert its installation CD/DVD. Please have the disc ready. For further information about automatic hardware recognition, searching for and installing hardware drivers, please refer to the documentation of your operating system. USB Audio is an integral part of Microsoft Windows, so no further software installation is necessary. After installing the necessary hardware drivers the MAP 1 will be integrated automatically into your computer system from now on and is ready to use after plugging in the USB cable.

Microsoft Windows will setup the MAP 1 automatically as standard device for sound playback. In case this is not done automatically due to your current system configuration, please set the corresponding option manually. To do so, open up the 'Sounds and Audio Devices' dialog of your Windows Settings menu. Click on the tag 'Audio' and select 'Audionet MAP1' from the list of standard devices (see following example):

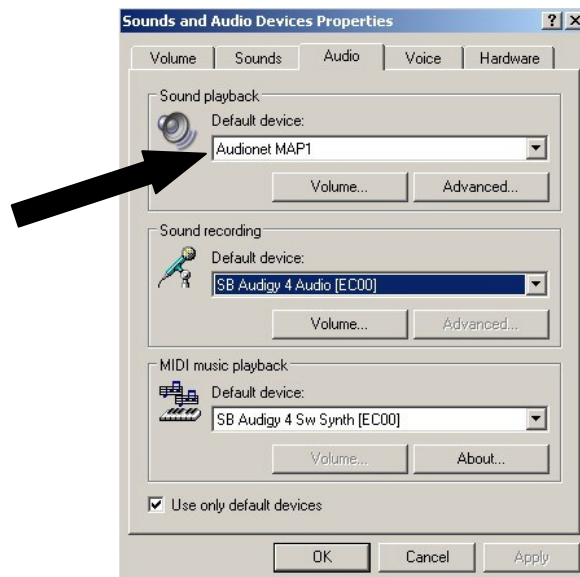

Now all music and sound files, that Microsoft Windows or your sound application is capable of processing, are played back with your MAP 1.



#### Note:

- Microsoft Windows converts every input format automatically into a stereo PCM signal with 44.1 or 48 kHz sampling frequency and 16 bits resolution. Which audio formats are played back depends the capabilities of your Microsoft Windows system and/or your sound application only.
- All volume and balance settings of Microsoft Windows or your sound application will be still active. In case you hear no sound at all or the sound has a low volume while playing back sound and music files with your MAP 1, please make sure that your volume settings of your Windows system are not muted or set to a low level.

- The USB Audio input of the MAP 1 is a fully-fledged digital input like all other inputs. Therefore, you can use all features of the MAP 1 with the USB Audio input, too, that apply to stereo PCM signals like Dolby Pro Logic IIx or DTS Neo:6. Also, the parametric digital equalizer is available as well as bass and delay management.
- If the USB Audio connection from your computer to the MAP 1 is interrupted, the MAP 1 will issue the warning **Receiver Out Of Lock!**. When the connection is established again, the MAP 1 will prompt the same messages as with all other digital inputs (*see chapter 'Display'*).
- In case you would like to check, if Microsoft Windows recognized your MAP 1 correctly, please open up the Device Manager of your Windows system. You will find the MAP 1 in the following 3 places in the list of devices:

Sound, video and game controllers	→	USB Audio Device
Human Interface Devices	→	USB Human Interface Device
Universal Serial Bus controllers	→	USB Composite Device.

The diagram on the following page gives an overview of an example list of entries in the Device Manager.

## Example entries in Device Manager:

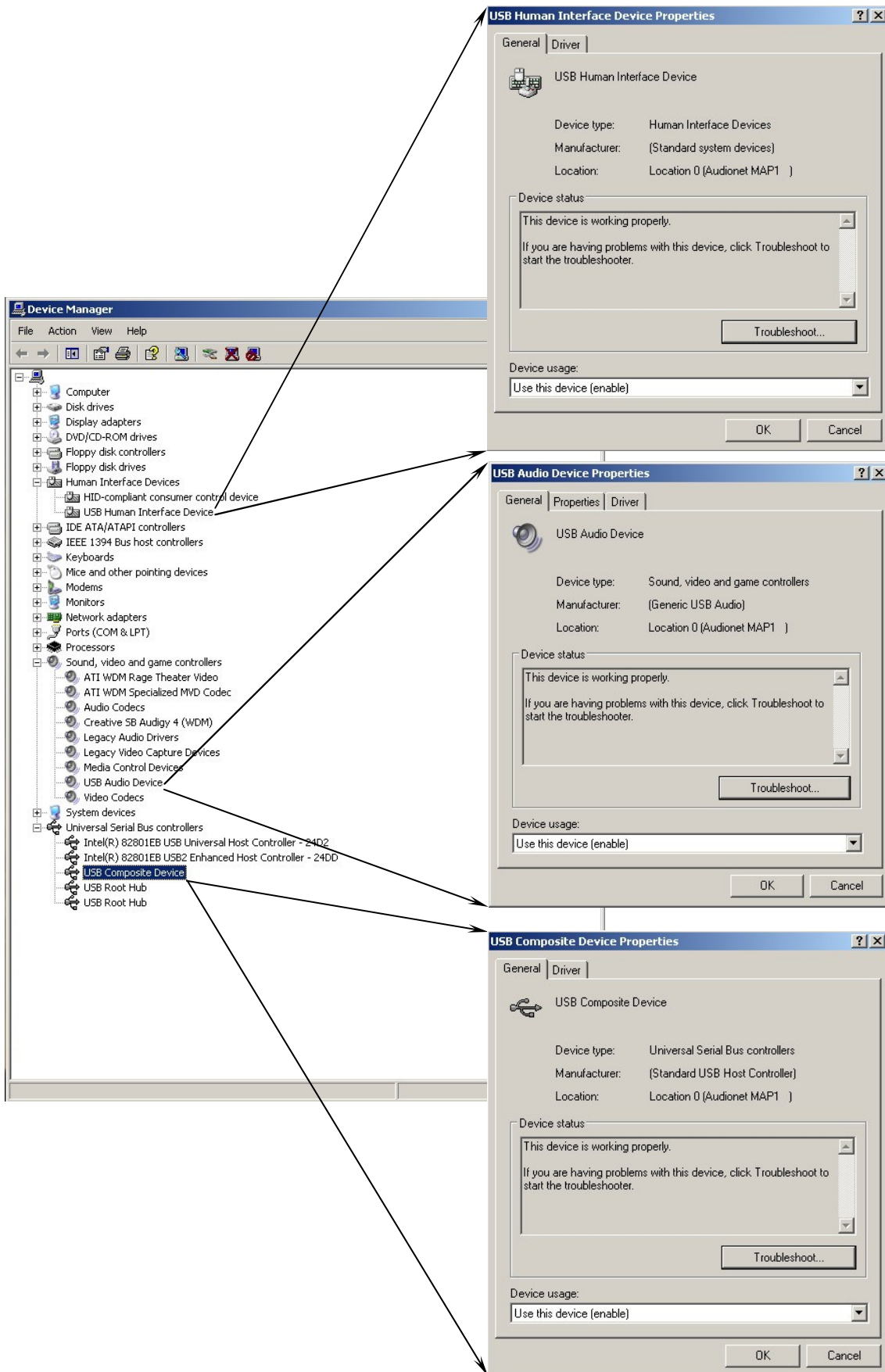

## Security advice

- Avoid packaging material, especially plastic bags, to come into children's hands.
- Store and operate the unit in a dry room at a reasonable room temperature
- Avoid moisture or any liquid to get into the unit
- Set up the unit in a sufficiently ventilated place
- **Do not cover**, e.g. with a blanket
- **Do not open** the case. Unauthorised opening will cause loss of guarantee.
- Use a dry cloth for cleaning

We would like to wish you many exciting listening experiences with your new Audionet product!

If you still have any questions, don't hesitate to ask your competent Audionet dealer.

*\*Manufactured under license from Dolby Laboratories. "Dolby", "Pro Logic", "Surround EX", and the double-D symbol are trademarks of Dolby Laboratories.*

*\*\* Manufactured under license from Digital Theater Systems, Inc. U.S. Pat. No's. 5,451,942; 5,956,674; 5,974,380; 5,978,762; 6,226,616; 6,487,535 and other U.S. and world-wide patents issued and pending. "DTS", "DTS-ES", "Neo:6", and "DTS 96/24" are trademarks of Digital Theater Systems, Inc. Copyright 1996, 2003 Digital Theater Systems, Inc. All Rights Reserved.*

*Microsoft, Windows, Windows Me, Windows XP, Windows Vista, Windows 7 are trademarks of Microsoft Corporation. All trademarks are the property of their respective owners.*

Errors and omissions excepted. Specifications and design are subject to changes without prior notice.

**AUDIONET** is a trademark of Idektron GmbH & Co KG

Engineered and produced by:  
Idektron GmbH & Co. KG, Alboinstraße 36 - 42, 12103 Berlin, Germany  
[www.audionet.de](http://www.audionet.de)  
[contact@audionet.de](mailto:contact@audionet.de)